

BOOK CIR

ITALIAN TILE COLLECTIONS

Design, style and quality tiles since 1967







LISTINO PREZZI 2014
PRICE LIST. TARIF. PREISLISTE. ПРАЙС ЛИСТ

INDICE - INDEX - INDEX - VERZEICHNIS - СОДЕРЖАНИЕ

Anni '70 pag.18	Milano 2015 pag.12
Antiqua pag.41	Progetto Bianco-Nero pag.13
Barrique pag.33	Quarry Stone pag.49
Biarritz pag.03	Quintana pag.42
Caleidos pag.50	Riabita il Cotto pag.08
Concept pag.51	Roma'53 pag.13
Cir Diciannove...Biarritz pag.07....St Tropez pag.29	Saint Barth pag.30
Cottage pag.32	Saint Tropez pag.28
Cotto Vogue pag.22	Taiga pag.31
Deserti pag.45	Tentazioni pag.26
Flair pag.25	Underground pag.20
Fuel pag.46	Via Emilia pag.14
In tinta pag.35	
I Pavimenti della Costa Smeralda pag.34	
Marble Age pag.38	Lavelli pag.52
Marble Style pag.36	Appendice Tecnica pag.53

LEGENDA - LEGEND - LEGEND - ZEICHENERKLÄRUNG - УСЛОВНЫЕ ЗНАКИ

	\neq		<i>s/n</i> (s/1, 2, 3...)		
Gres fine porcellanato Cir Cir fine porcelain stoneware Grès cérame fin Cir Cir Feinsteinzeug	Spessore Thickness Epaisseur Stärke	Ingelività Frost resistance Résistance au gel Frostbeständigkeit	Numero di pezzi per singolo decoro Number of pieces for single decor Nombre de pièces par décor Nummer von Stücke für jeden Dekor	Tecnologia digitale Digital technology Technologie Digitale Digitaldruck Technologie	Superficie Antislip Antislip surface Surface antiderant Antislip Oberfläche

- Ceramica Cir si riserva la facoltà di modificare in qualunque momento le informazioni e le caratteristiche tecniche illustrate nel presente listino, che non sono comunque da ritenere legalmente vincolanti.
- Pesi e misure possono subire variazioni tipiche del particolare processo di cottura del materiale ceramico.
- Tutti i formati si intendono nominali.
- I prezzi si intendono per merce resa franco ns. stabilimento, IVA e trasporto esclusi.
- Le tonalità dei nostri campioni sono da ritenere puramente indicative e quindi soggette a variazioni.
- Tutti i materiali e decori non indicati nel presente listino si intendono fuori produzione.
- PALLET FAO. (80x120) € 8,00 - MINI PALLET FAO. (80x80 - 50x80) € 4,70.
- Consigli di posa e pulizia, manutenzione, norme iso, raccomandazioni e avvertenze sul sito web www.cir.it.

- Ceramica Cir reserves the right, at any time and without prior notice, to change the information and technical characteristics give in this price list none of which are to be considered legally binding.
- Weights and dimensions are subject to the normal variations resulting from the ceramic firing process.
- All sizes are to be considered nominal.
- Our prices are ex-factory and they do not include IVA and transport.
- The shades of our samples are merely approximate and subject to variations.
- Every item (plain or decor tiles) not included in this price list is to be considered out of production.
- PALLET FAO. (80x120) € 8,00 - MINI PALLET FAO. (80x80 - 50x80) € 4,70.
- Laying and cleaning suggestion, maintenance, iso norms, additional indication on website www.cir.it.

- Ceramica Cir se réserve la faculté de modifier à tout moment les informations et les caractéristiques techniques figurant dans le présent tarif, qui ne sauraient en aucun cas engager le fabricant.
- Poids et dimensions peuvent être l'objet de variations, lesquelles sont propres au procédé de cuisson du matériau céramique.
- Chaque format doit être entendu comme format nominal.
- Les prix bruts indiqués s'entendent départ usine, TVA et transport exclus.
- Les tonalités de nos échantillons sont à considerer indicatives, par conséquent passibles de variations.
- Tous les produits, unis et décors, qui n'apparaissent plus sur ce tarif, sont hors-production.
- PALLET FAO. (80x120) € 8,00 - MINI PALLET FAO. (80x80 - 50x80) € 4,70.
- Conseils de pose et de nettoyage, entretien, normes ISO, renseignements et informations sur le site www.cir.it.

- Ceramica Cir behält sich das Recht vor, die in dieser Preisliste enthaltenen, unverbindlichen Angaben und technischen Eigenschaften jederzeit zu verändern.
- Gewichte und Abmessungen können infolge des besonderen Brennverfahrens des Keramikmaterials variieren.
- Alle Formate verstehen sich als Nennformate.
- Die Preise verstehen sich ab Werk, zuzüglich Mehrwertsteuer und Frachtkosten.
- Die Tonalität unserer Muster ist nicht verbindlich und kann sich mit jeder Lieferung ändern.
- Alle Fliesen und Dekore, die nicht mehr in der Preisliste aufgelistet sind, werden nicht mehr produziert.
- PALLET FAO. (80x120) € 8,00 - MINI PALLET FAO. (80x80 - 50x80) € 4,70.
- Verlege- und Reinigungshinweise, Pflege, ISO-Normen und weitere Informationen auf der Webseite www.cir.it.

IL PRESENTE LISTINO ANNULLA E SOSTITUISCE OGNI LISTINO PRECEDENTE - THIS PRICE LIST CANCELS AND REPLACES ANY PREVIOUS PRICE LIST
 CE TARIF ANNULE ET REMPLACE TOUTES LES PRÉCÉDENTES - DIESE PREISLISTE ANNULLIERT UND ERSETZT DIE VORHERIGE PREISLISTE
 ЭТОТ ПРАЙС АННУЛИРУЕТ И ЗАМЕНЯЕТ ВСЕ ПРЕДЫДУЩИЕ ПРАЙСЫ

FORMA&FORMATO SHAPE & SIZE FORME ET FORMAT FORM UND FORMAT	ARTICOLO ITEM ARTICLE ARTIKEL	1° SCELTA PREZZO SFUSO	COMM. PREZZO SFUSO	Pz x Box	Mq x Box	Kg x Box	Box x Pall.	Mq x Pall.	Kg x Pall.
		1° CHOIX LOOSE PRICE 1 WAHL PREIS LOSE	COMM. LOOSE PRICE COMM. PRIX EN VRAC HW PREIS LOSE						
 10x10 ± 12 mm WAIKIKI (26 soggetti mix) 10x10 ± 12 mm	 ARDOISE CENDRE COGNAC ÉCRU MÉLANGE (composto da Cendre-Écru)	50,00	30,00	Imballaggio SFUSO LOOSE EN VRAC LOSE					
		50,00	30,00	10x10					
		50,00	30,00	60	0,60	15,00	72	43,20	1.096
		50,00	30,00						
		50,00	30,00						
		50,00	30,00						
 20x20 - 20x20 R11 ± 12 mm WAIKIKI (26 soggetti mix) 20x20 - 20x20 R11 ± 12 mm	 ARDOISE - ARDOISE R11 CENDRE -CENDRE R11 COGNAC - COGNAC R11 ÉCRU - ÉCRU R11 MÉLANGE - MÉLANGE R11 (composto da Cendre-Écru)	46,00	28,00	Imballaggio SFUSO LOOSE EN VRAC LOSE					
		46,00	28,00	20x20					
		46,00	28,00	22	0,88	20,60	54	47,52	1.129
		46,00	28,00						
		46,00	28,00						
		46,00	28,00						
 20x40 - 20x40 R11 ± 12 mm	 ARDOISE - ARDOISE R11 CENDRE -CENDRE R11 COGNAC - COGNAC R11 ÉCRU - ÉCRU R11 MÉLANGE - MÉLANGE R11 (composto da Cendre-Écru)	46,00	28,00	Imballaggio SFUSO LOOSE EN VRAC LOSE					
		46,00	28,00	20x40					
		46,00	28,00	11	0,88	20,60	54	47,52	1.129
		46,00	28,00						
		46,00	28,00						
		46,00	28,00						
 40x40 - 40x40 R11 ± 12 mm WAIKIKI (14 soggetti mix) 40x40 - 40x40 R11 ± 12 mm	 ARDOISE - ARDOISE R11 CENDRE -CENDRE R11 COGNAC - COGNAC R11 ÉCRU - ÉCRU R11 MÉLANGE - MÉLANGE R11 (composto da Cendre-Écru)	46,00	28,00	Imballaggio SFUSO LOOSE EN VRAC LOSE					
		46,00	28,00	40x40					
		46,00	28,00	7	1,12	26,80	48	53,76	1.303
		46,00	28,00	6	0,96	22,70	52	46,08	1.197
		46,00	28,00						
		46,00	28,00						

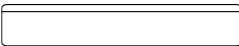
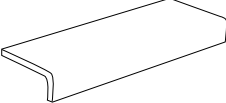
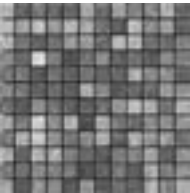
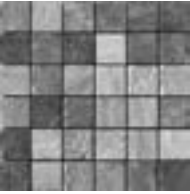
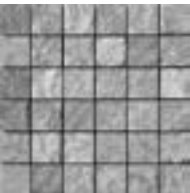
FORMA&FORMATO SHAPE & SIZE FORME ET FORMAT FORM UND FORMAT	ARTICOLO ITEM ARTICLE ARTIKEL	1° SCELTA PREZZO SFUSO 1° CHOICE LOOSE PRICE 1 CHOIX PRIX EN VRAC 1 WAHL PREIS LOSE €. mq	COMM. PREZZO SFUSO COMM. LOOSE PRICE COMM. PRIX EN VRAC HW PREIS LOSE €. mq		Pz x Box	Mq x Box	Kg x Box	Box x Pall.	Mq x Pall.	Kg x Pall.
 40x80 - 40x80 R11 ≠ 12 mm	ARDOISE - ARDOISE R11 CENDRE -CENDRE R11 COGNAC - COGNAC R11 ÉCRU - ÉCRU R11 MÉLANGE - MÉLANGE R11 (composto da Cendre-Écru)	57,00 57,00 57,00 57,00 57,00	34,00 34,00 34,00 34,00 34,00		Imballaggio SFUSO LOOSE EN VRAC LOSE 40x80 3 0,96 24,00 28 26,88 688					
 BATTISCOPIA 8x40	ARDOISE CENDRE COGNAC ÉCRU	€. ml 13,00 13,00 13,00 13,00	8,00 8,00 8,00 8,00		Imballaggio SFUSO LOOSE EN VRAC LOSE Battiscopa 8x40 20 8,00 16,80 42 336 720					
 *ELEMENTO AD "L" R11 MONOLITICO 10x40x5	ARDOISE CENDRE COGNAC ÉCRU	22,00 22,00 22,00 22,00			Imballaggio SFUSO LOOSE EN VRAC LOSE Elemento ad "L" 10x40x5 8 - 9,20 35 - 338					
	MOSAICI Mosaics - Mosaiques - Mosaiken	€. foglio sheet/feuille/Blatt								
 MOSAICO BIARRITZ MIX TESSERA 2,2x2,2 FOGLIO/SHEET/FEUILLE/BLATT 30x30	MIX GRIGIO (Ardoise-Cendre) MIX BEIGE (Cognac-Écru) MIX MÉLANGE	20,00 20,00 20,00			Imballaggio SFUSO LOOSE EN VRAC LOSE 5 0,45 11,00 60 27,60 675					
 MOSAICO BIARRITZ MIX TESSERA 5x5 FOGLIO/SHEET/FEUILLE/BLATT 30x30  MOSAICO WAIKIKI TESSERA 5x5 FOGLIO/SHEET/FEUILLE/BLATT 30x30	MIX GRIGIO (Ardoise-Cendre) MIX BEIGE (Cognac-Écru) MIX MÉLANGE WAIKIKI CENDRE WAIKIKI ÉCRU	16,00 16,00 16,00 18,00 18,00			Imballaggio SFUSO LOOSE EN VRAC LOSE 5 0,45 11,00 60 27,60 675					

FORMA&FORMATO SHAPE & SIZE FORME ET FORMAT FORM UND FORMAT		ARTICOLO ITEM ARTICLE ARTIKEL	1° SCELTA PREZZO SFUSO 1° CHOICE LOOSE PRICE 1 CHOIX PRIX EN VRAC 1 WAHL PREIS LOSE	COMM. PREZZO SFUSO COMM. LOOSE PRICE COMM. PRIX EN VRAC HW PREIS LOSE		Pz x Box	Mq x Box	Kg x Box	Box x Pall.	Mq x Pall.	Kg x Pall.							
		MOSAICI Mosaics - Mosaïques - Mosaiken	€ . foglio sheet/feuille/Blatt															
 MOSAICO SPACCO R11 TESSERA 7,5x7,5 FOGLIO/SHEET/FEUILLE/BLATT 30x40		ARDOISE R11 CENDRE R11 COGNAC R11 ÉCRU R11 MÉLANGE R11 (composto da Cendre-Écru)	15,00 15,00 15,00 15,00 15,00			Pz x Box	Mq x Box	Kg x Box	Box x Pall.	Mq x Pall.	Kg x Pall.							
					5	0,60	15,00	36	21,60	556								
FORMA SHAPE FORME FORM	FORMATO SIZE FORMAT FORMAT	ARTICOLO ITEM ARTICLE ARTIKEL	1° SCELTA PREZZO SFUSO 1° CHOICE LOOSE PRICE 1 CHOIX PRIX EN VRAC 1 WAHL PREIS LOSE	1° SCELTA PREZZO SFUSO 1° CHOICE LOOSE PRICE 1 CHOIX PRIX EN VRAC 1 WAHL PREIS LOSE	PZZ. PER SCAT. PCS PER BOX PCS PER BOÎTE ST. PRO KARTON	VERSIONE DI COLORE VERSION OF COLOUR VERSION COULEUR FARBEAUSFÜHRUNG												
		DECORAZIONI Decorations - Décors - Dekorationen	€ . mq	€ . pz														
		DECORAZIONI Decorations - Décors - Dekorationen	PZZ. PER SCAT. PCS PER BOX PCS PER BOÎTE ST. PRO KARTON 24 pzz.															
	10x10	Inserto Paradise s/6		10,00	6	Cendre/Écru												
	20x20	Inserto Paradise s/6	180,00	12,00	6													
	20x20	Inserto Paradise A	180,00	12,00	6													
	20x20	Inserto Paradise B	180,00	12,00	6													
	20x20	Inserto Paradise C	180,00	12,00	6													
	20x20	Inserto Paradise D	180,00	12,00	6													
	20x20	Inserto Paradise E	180,00	12,00	6													
	20x20	Inserto Paradise F	180,00	12,00	6													
		10x10	Inserto Aloha s/6		11,00							6	Cendre/Écru/Mélange					
		20x20	Inserto Aloha s/6	200,00	13,00							6						
	2,5x20	Sigaro Biarritz		10,00	24	Ardoise/Cognac												
FORMA SHAPE FORME FORM	ARTICOLO ITEM ARTICLE ARTIKEL	1° SCELTA PREZZO SFUSO 1° CHOICE LOOSE PRICE 1 CHOIX PRIX EN VRAC 1 WAHL PREIS LOSE	PZZ. PER SCAT. PCS PER BOX PCS PER BOÎTE ST. PRO KARTON	FORMA SHAPE FORME FORM	ARTICOLO ITEM ARTICLE ARTIKEL	1° SCELTA PREZZO SFUSO 1° CHOICE LOOSE PRICE 1 CHOIX PRIX EN VRAC 1 WAHL PREIS LOSE	PZZ. PER SCAT. PCS PER BOX PCS PER BOÎTE ST. PRO KARTON											
	PEZZI SPECIALI Special pieces - Pièces spéciales Spezielle Stücke	€ . pz			PEZZI SPECIALI 10x10 Special pieces - Pièces spéciales Spezielle Stücke	€ . pz												
	*Gradone Square Biarritz	53,00	4		*Torello 1	22,00	2											
	*Gradone Square Biarritz R11 32x40	53,00			*Spigolo 3	24,00	1											
	*Frontale gradino con Lamella 4,3x40	33,00	4															
	*Spigolo Frontale 4,3x4,3	10,00	1															
<p>*Disponibile anche nel colore Mélange, solo su richiesta, con una maggiorazione del 15% dal prezzo di listino. *Available on colour Mélange upon request, with a price increase of 15%. *Disponible aussi dans la couleur Mélange, sur demande, avec une hausse de 15% sur le prix du tarif en vigueur. *Auf Anfrage mit einem Preisaufschlag von 15% wird auch in der Farbe Melange geliefert.</p>																		

Schemi di Posa Modulare . Modular Laying Sketch. Schémas de Pose Modulaire. Modulverlegungsbeispiele.

MODULARE 10

1 - 20x20...14,3%
2 - 20x40...28,6%
3 - 40x40...57,1%

FONDO: 1° SCELTA MQ € 50,00

A: DECORO WAIKIKI (20x20-40x40): 1° SCELTA MQ € 56,00

B: DECORO WAIKIKI (20x20): 1° SCELTA MQ € 52,00

C: DECORO WAIKIKI (40x40): 1° SCELTA MQ € 55,00

MODULARE 18

1 - 20x20...11,1%
2 - 20x40...44,45%
3 - 40x40...44,45%

FONDO: 1° SCELTA MQ € 50,00

A: DECORO WAIKIKI (20x20-40x40): 1° SCELTA MQ € 55,00

B: DECORO WAIKIKI (20x20): 1° SCELTA MQ € 51,00

C: DECORO WAIKIKI (40x40): 1° SCELTA MQ € 54,00

MODULARE 19

1 - 20x20...11,1%
2 - 20x40...44,45%
3 - 40x40...44,45%

FONDO: 1° SCELTA MQ € 50,00

A: DECORO WAIKIKI (20x20-40x40): 1° SCELTA MQ € 55,00

B: DECORO WAIKIKI (20x20): 1° SCELTA MQ € 51,00

C: DECORO WAIKIKI (40x40): 1° SCELTA MQ € 54,00

MODULARE 20

2 - 20x40...50%
3 - 40x40...50%

FONDO: 1° SCELTA MQ € 50,00

A: DECORO WAIKIKI (40x40): 1° SCELTA MQ € 55,00

MODULARE 21

1 - 20x20...20%
3 - 40x40...80%

FONDO: 1° SCELTA MQ € 50,00

A: DECORO WAIKIKI (20x20-40x40): 1° SCELTA MQ € 59,00

B: DECORO WAIKIKI (20x20): 1° SCELTA MQ € 52,00

C: DECORO WAIKIKI (40x40): 1° SCELTA MQ € 57,00

MODULARE 25

2 - 20x40...14,3%
3 - 40x40...28,6%
4 - 40x80...57,1%

FONDO: 1° SCELTA MQ € 57,00

A: DECORO WAIKIKI (40x40): 1° SCELTA MQ € 60,00

MODULARE 26

2 - 20x40...14,3%
3 - 40x40...28,6%
4 - 40x80...57,1%

FONDO: 1° SCELTA MQ € 57,00

A: DECORO WAIKIKI (40x40): 1° SCELTA MQ € 60,00

MODULARE 27

1 - 20x20...6,66%
2 - 20x40...13,34%
3 - 40x40...26,66%
4 - 40x80...53,33%

FONDO: 1° SCELTA MQ € 57,00

A: DECORO WAIKIKI (20x20-40x40): 1° SCELTA MQ € 60,00

B: DECORO WAIKIKI (20x20): 1° SCELTA MQ € 57,00

C: DECORO WAIKIKI (40x40): 1° SCELTA MQ € 59,00

MODULARE 28

2 - 10x10...7,72%
3 - 20x20...30,76%
4 - 20x40...61,52%

FONDO: 1° SCELTA MQ € 51,00

A: DECORO WAIKIKI (10x10-20x20): 1° SCELTA MQ € 54,00

B: DECORO WAIKIKI (20x20): 1° SCELTA MQ € 54,00

C: DECORO WAIKIKI (10x10): 1° SCELTA MQ € 52,00

Schemi di Posa . Laying Sketch. Schémas de Pose. Modulverlegungsbeispiele.



***MODULARE ALOHA**
(1 Mq Nominale)
(nei colori: Écru, Cendre, Mèlange)
(Solo da rivestimento - Fixing for wall only)
Pose que pour le revêtement mural
Nur fuer die Wandklebung geeignet
Композиция только для укладки на стену)
Fondo 10x10 = 26 pzz
Fondo 20x20 = 11 pzz
Inserto Aloha s/6 10x10 = 6 pzz
Inserto Aloha s/6 20x20 = 6 pzz



***MODULARE PARADISE**
(1 Mq Nominale)
(nei colori: Écru, Cendre)
Fondo 10x10 = 26 pzz
Fondo 20x20 = 11 pzz
Inserto Paradise s/6 10x10 = 6 pzz
Inserto Paradise s/6 20x20 = 6 pzz

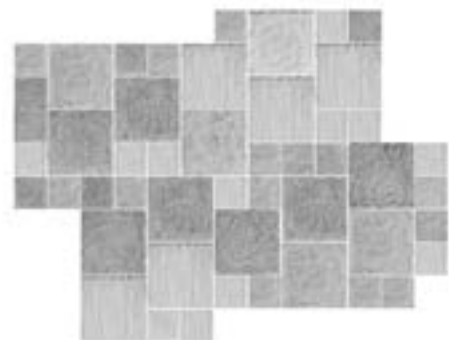

***MODULARE WAIKIKI**
(1 Mq Nominale)
(nei colori: Ardoise, Cendre, Cognac, Écru)
Fondo 10x10 = 26 pzz
Fondo 20x20 = 11 pzz
Inserto Waikiki Mix 10x10 = 6 pzz
Inserto Waikiki Mix 20x20 = 6 pzz

*Per il prezzo del modulare richiedere il preventivo in azienda. *For the price of the modular pattern please ask for a quotation to the company.
*Veuillez demander au service commercial le préventif du modulaire. *Fuer den Modulpreis bitte im Werk anfragen.
*Цену для модульной укладки можно узнать на фабрике.



19 mm - "13/16"
spessore
thickness

NOVITÀ



CIR DICIANNOVE

Biarritz
Diciannove



FORMA&FORMATO SHAPE & SIZE FORME ET FORMAT FORM UND FORMAT		ARTICOLO ITEM ARTICLE ARTIKEL		1° SCELTA PREZZO SFUSO 1° CHOIX LOOSE PRICE 1 CHOIX PRIX EN VRAC 1 WAHL PREIS LOSE	COMM. PREZZO SFUSO COMM. LOOSE PRICE COMM. PRIX EN VRAC HW PREIS LOSE	Pz x Box	Mq x Box	Kg x Box	Box x Pall.	Mq x Pall.	Kg x Pall.
	60x60 R11 RETT ± 19 mm	ARDOISE R11 rett		95,00	53,00	Imballaggio SFUSO LOOSE EN VRAC LOSE					
		CENDRE R11 rett		95,00	53,00	60x60					
		ÉCRU R11 rett		95,00	53,00	2	0,72	30,80	32	23,04	1.002
FORMA SHAPE FORME FORM	ARTICOLO ITEM ARTICLE ARTIKEL	1° SCELTA PREZZO SFUSO 1° CHOIX LOOSE PRICE 1 CHOIX PRIX EN VRAC 1 WAHL PREIS LOSE	PZZ. PER SCAT. PCS PER BOX PCS PER BOÎTE ST. PRO KARTON	FORMA SHAPE FORME FORM	ARTICOLO ITEM ARTICLE ARTIKEL	1° SCELTA PREZZO SFUSO 1° CHOIX LOOSE PRICE 1 CHOIX PRIX EN VRAC 1 WAHL PREIS LOSE	PZZ. PER SCAT. PCS PER BOX PCS PER BOÎTE ST. PRO KARTON				
PEZZI SPECIALI - Special pieces - Pièces spéciales Spezielle Stücke											
	Step molato R11 rettificato 30x60	46,00	3		Elemento ad "L" R11 rettificato 15x60x5	78,00	4				
Disponibili in tutti i colori - Available in all colours - Disponibles dans toutes les couleurs - In allen Farben lieferbar											

Supporti per posa sopraelevata

Raised floor supports. Plots pour pose surélevée. Stelzlager fuer die schwimmende Verlegung. Опора для фальшполов

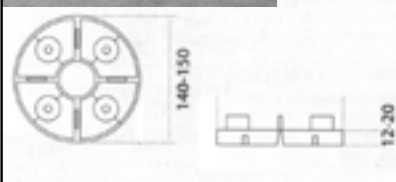
SUPPORTO FISSO
FIXED SUPPORT
SUPPORT FIXE
FESTE TRAGSTRUKUR

h 12 mm € 0,50 pz



SUPPORTO REGOLABILE
ADJUSTABLE SUPPORT
SUPPORT RÉGLABLE
VERSTELLBARE TRAGSTRUKUR

h 25/40 mm € 5,00 pz
h 40/70 mm € 5,80 pz
h 60/100 mm € 6,60 pz



SUPPORTO AUTOLIVELLANTE
SELF-LEVELLING SUPPORT
SUPPORT AUTONIVELANT
SELBSTNIVELLIERENDE TRAGSTRUKUR

h 37/50 mm € 8,50 pz
h 50/75 mm € 8,90 pz

FORMA&FORMATO SHAPE & SIZE FORME ET FORMAT FORM UND FORMAT	ARTICOLO ITEM ARTICLE ARTIKEL	1° SCELTA PREZZO SFUSO	COMM. PREZZO SFUSO	Pz x Box	Mq x Box	Kg x Box	Box x Pall.	Mq x Pall.	Kg x Pall.		
		1° CHOIX LOOSE PRICE 1 CHOIX PRIX EN VRAC 1 WAHL PREIS LOSE	COMM. LOOSE PRICE COMM. PRIX EN VRAC HW PREIS LOSE							€ .mq	€ .mq
 10x10 ± 10,5 mm FABRIC (24 soggetti mix) 10x10 ± 10,5 mm	 CLASSIC FENG SHUI INDUSTRIAL MINIMAL NATURAL SHABBY CHIC FABRIC CLASSIC FABRIC FENG SHUI FABRIC INDUSTRIAL FABRIC MINIMAL FABRIC NATURAL FABRIC SHABBY CHIC RIABITA MIX MINIMAL: (Industrial, Minimal, Shabby Chic) RIABITA MIX NATURAL: (Classic, Feng Shui, Minimal, Natural) FABRIC MIX MINIMAL (Industrial, Minimal, Shabby Chic) FABRIC MIX NATURAL (Classic, Feng Shui, Minimal, Natural)	48,00	30,00	Imballaggio SFUSO LOOSE EN VRAC LOSE							
		48,00	30,00	10x10							
		48,00	30,00	68	0,68	15,45	72	48,96	1.128		
		48,00	30,00								
		48,00	30,00								
		48,00	30,00								
		48,00	30,00								
		48,00	30,00								
		48,00	30,00								
		48,00	30,00								
 10x20 ± 10,5 mm	 CLASSIC FENG SHUI INDUSTRIAL MINIMAL NATURAL SHABBY CHIC	52,00	31,00	Pz x Box	Mq x Box	Kg x Box	Box x Pall.	Mq x Pall.	Kg x Pall.		
		52,00	31,00	Imballaggio SFUSO LOOSE EN VRAC LOSE							
		52,00	31,00	10x20							
		52,00	31,00	25	0,50	11,00	108	54,00	1.203		
		52,00	31,00	48	0,96	20,30	54	51,84	1.112		
		52,00	31,00								
		52,00	31,00								
		52,00	31,00								
		52,00	31,00								
		52,00	31,00								
 20x20 ± 10,5 mm FABRIC (24 soggetti mix) 20x20 ± 10,5 mm	 CLASSIC FENG SHUI INDUSTRIAL MINIMAL NATURAL SHABBY CHIC FABRIC CLASSIC FABRIC FENG SHUI FABRIC INDUSTRIAL FABRIC MINIMAL FABRIC NATURAL FABRIC SHABBY CHIC RIABITA MIX MINIMAL: (Industrial, Minimal, Shabby Chic) RIABITA MIX NATURAL: (Classic, Feng Shui, Minimal, Natural) FABRIC MIX MINIMAL (Industrial, Minimal, Shabby Chic) FABRIC MIX NATURAL (Classic, Feng Shui, Minimal, Natural)	43,00	26,00	Pz x Box	Mq x Box	Kg x Box	Box x Pall.	Mq x Pall.	Kg x Pall.		
		43,00	26,00	Imballaggio SFUSO LOOSE EN VRAC LOSE							
		43,00	26,00	20x20							
		43,00	26,00	24	0,96	20,30	54	51,84	1.112		
		43,00	26,00								
		43,00	26,00								
		43,00	26,00								
		43,00	26,00								
		43,00	26,00								
		43,00	26,00								
 20x40 ± 10,5 mm	 CLASSIC FENG SHUI INDUSTRIAL MINIMAL NATURAL SHABBY CHIC	43,00	26,00	Pz x Box	Mq x Box	Kg x Box	Box x Pall.	Mq x Pall.	Kg x Pall.		
		43,00	26,00	Imballaggio SFUSO LOOSE EN VRAC LOSE							
		43,00	26,00	20x40							
		43,00	26,00	12	0,96	21,00	54	51,84	1.150		
		43,00	26,00								
		43,00	26,00								
		43,00	26,00								
		43,00	26,00								
		43,00	26,00								
		43,00	26,00								
 24x24 *Ottagona lato 10 ± 10,5 mm	 OTTAGONA INDUSTRIAL OTTAGONA MINIMAL OTTAGONA NATURAL	58,00	34,00	Imballaggio SFUSO LOOSE EN VRAC LOSE							
		58,00	34,00	24x24							
		58,00	34,00	19	0,92	19,4	39	35,88	772		
						 MODULO OTTAGONA OTTAGONA = 82,7% 10x10 = 17,3%					

(*) Possibile abbinamento con: 10x10 (tutti i colori); Insetto Brush 10x10; Insetto Pattern 10x10.
 (†) Possible matchable with: 10x10 (all colours); Insetto Brush 10x10; Insetto Pattern 10x10.
 (‡) Possible assortissement avec: 10x10 (toutes les couleurs); Insetto Brush 10x10; Insetto Pattern 10x10.
 (§) Möglich kombiniert mit: 10x10 (alle Farben); Insetto Brush 10x10; Insetto Pattern 10x10.

FORMA&FORMATO SHAPE & SIZE FORME ET FORMAT FORM UND FORMAT	ARTICOLO ITEM ARTICLE ARTIKEL	1° SCELTA PREZZO SFUSO 1° CHOICE LOOSE PRICE 1 CHOIX PRIX EN VRAC 1 WAHL PREIS LOSE € . mq	COMM. PREZZO SFUSO COMM. LOOSE PRICE COMM. PRIX EN VRAC HW PREIS LOSE € . mq		Pz x Box	Mq x Box	Kg x Box	Box x Pall.	Mq x Pall.	Kg x Pall.							
<p>ESAGONA 24x27,7 ± 10,5 mm</p> <p>ESAGONA FABRIC (20 soggetti mix) 24x27,7 ± 10,5 mm</p>	<p>ESAGONA CLASSIC ESAGONA FENG SHUI ESAGONA INDUSTRIAL ESAGONA MINIMAL ESAGONA NATURAL ESAGONA SHABBY CHIC</p>	<p>60,00 60,00 60,00 60,00 60,00 60,00</p>	<p>35,00 35,00 35,00 35,00 35,00 35,00</p>		Pz x Box	Mq x Box	Kg x Box	Box x Pall.	Mq x Pall.	Kg x Pall.							
	<p>ESAGONA FABRIC CLASSIC ESAGONA FABRIC FENG SHUI ESAGONA FABRIC INDUSTRIAL ESAGONA FABRIC MINIMAL ESAGONA FABRIC NATURAL ESAGONA FABRIC SHABBY CHIC</p> <p>ESAGONA RIABITA MIX MINIMAL: (Industrial, Minimal, Shabby Chic) ESAGONA RIABITA MIX NATURAL: (Classic, Feng Shui, Minimal, Natural)</p> <p>ESAGONA FABRIC MIX MINIMAL (Industrial, Minimal, Shabby Chic) ESAGONA FABRIC MIX NATURAL (Classic, Feng Shui, Minimal, Natural)</p>	<p>68,00 68,00 68,00 68,00 68,00 68,00</p> <p>68,00 68,00</p> <p>78,00 78,00</p>	<p>39,00 39,00 39,00 39,00 39,00 39,00</p>		<p>Imballaggio SFUSO LOOSE EN VRAC LOSE ESAGONA 24x27,7</p> <table border="1"> <tr> <td>20</td> <td>0,97</td> <td>20,50</td> <td>39</td> <td>37,83</td> <td>815</td> </tr> </table>						20	0,97	20,50	39	37,83	815	
20	0,97	20,50	39	37,83	815												
<p>BATTISCOPA 8x40</p>	<p>CLASSIC FENG SHUI INDUSTRIAL MINIMAL NATURAL SHABBY CHIC</p>	<p>14,00 14,00 14,00 14,00 14,00 14,00</p>	€ . ml		Pz x Box	Ml x Box	Kg x Box	Box x Pall.	Ml x Pall.	Kg x Pall.							
						<p>Imballaggio SFUSO LOOSE EN VRAC LOSE Battiscopa 8x40</p> <table border="1"> <tr> <td>20</td> <td>8,00</td> <td>12,30</td> <td>48</td> <td>384,00</td> <td>606</td> </tr> </table>						20	8,00	12,30	48	384,00	606
20	8,00	12,30	48	384,00	606												
	MOSAICI Mosaics - Mosaiques - Mosaiken	€ . foglio sheet/feuille/Blatt			Pz x Box	Mq x Box	Kg x Box	Box x Pall.	Mq x Pall.	Kg x Pall.							
<p>MOSAICO RIABITA TESSERA 5x5 FOGLIO/SHEET/FEUILLE/BLATT 30x30</p>	<p>CLASSIC FENG SHUI INDUSTRIAL MINIMAL NATURAL SHABBY CHIC</p>	<p>15,00 15,00 15,00 15,00 15,00 15,00</p>			5	0,45	9,00	60	27,60	556							
<p>MOSAICO FABRIC TESSERA 5x5 FOGLIO/SHEET/FEUILLE/BLATT 30x30</p>	<p>FABRIC CLASSIC FABRIC FENG SHUI FABRIC INDUSTRIAL FABRIC MINIMAL FABRIC NATURAL FABRIC SHABBY CHIC</p>	<p>17,00 17,00 17,00 17,00 17,00 17,00</p>			5	0,45	9,00	60	27,60	556							
FORMA SHAPE FORME FORM	ARTICOLO ITEM ARTICLE ARTIKEL	1° SCELTA PREZZO SFUSO 1° CHOICE LOOSE PRICE 1 CHOIX PRIX EN VRAC 1 WAHL PREIS LOSE € . pz	PZZ. PER SCAT. PCS PER BOX PCS PER BOÎTE ST. PRO KARTON	FORMA SHAPE FORME FORM	ARTICOLO ITEM ARTICLE ARTIKEL	1° SCELTA PREZZO SFUSO 1° CHOICE LOOSE PRICE 1 CHOIX PRIX EN VRAC 1 WAHL PREIS LOSE € . pz	PZZ. PER SCAT. PCS PER BOX PCS PER BOÎTE ST. PRO KARTON										
	PEZZI SPECIALI Special pieces - Pièces spéciales Spezielle Stücke																
	Torello 1	22,00	2		Spigolo 3	24,00	1										

Disponibili nei colori: Available in the version of colours: Disponibles dans les couleurs: In den Farben lieferbar: Classic/Minimal/Natural/Shabby Chic

FORMA SHAPE FORME FORM	FORMATO SIZE FORMAT FORMAT	ARTICOLO ITEM ARTICLE ARTIKEL	1° SCELTA PREZZO SFUSO 1° CHOICE LOOSE PRICE 1 CHOIX PRIX EN VRAC 1 WAHL PREIS LOSE € .mq	1° SCELTA PREZZO SFUSO 1° CHOICE LOOSE PRICE 1 CHOIX PRIX EN VRAC 1 WAHL PREIS LOSE € .pz	PZZ. PER SCAT. PCS PER BOX PCS PER BOÎTE ST. PRO KARTON	VERSIONE DI COLORE VERSION OF COLOUR VERSION COULEUR FARBEAUSFÜHRUNG
		DECORAZIONI Decorations - Décors - Dekorationen	PZZ. PER SCAT. PCS PER BOX PCS PER BOÎTE ST. PRO KARTON 24 pzz.			
	10x10 20x20	Inserto Majolica s/6 Inserto Majolica s/6	200,00	10,00 13,00	6 6	Minimal/Shabby Chic
	10x10 10x10 20x20 20x20	Inserto Brush A Inserto Brush B Inserto Brush A Inserto Brush B	160,00 160,00	10,00 10,00 11,00 11,00	4 4 4 4	Minimal/Shabby Chic
	10x10 20x20 40x40 24x24	Inserto Pattern s/4 Inserto Pattern s/4 Inserto Pattern s/4 Ottagona Pattern s/4	*190,00 130,00 140,00 **185,00	10,00 13,00 34,00 13,00	4 4 4 4	Beige/Grey Beige/Black/Grey

*PZZ. PER SCAT. - PCS PER BOX - PCS PER BOX - ST. PRO KARTON: PZZ. 68

**PZZ. PER SCAT. - PCS PER BOX - PCS PER BOX - ST. PRO KARTON: PZZ. 20

Schemi di Posa . Laying Sketch. Schémas de Pose. Modulverlegungsbeispiele.

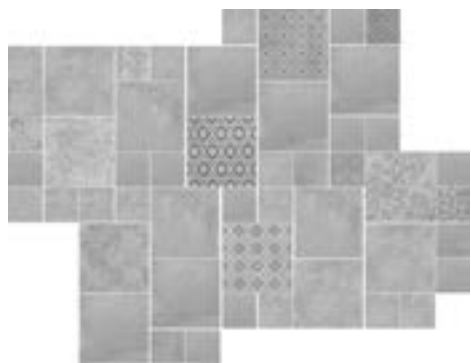

***MODULARE FABRIC**
(1 Mq Nominale)
(nei colori: Classic, Industrial, Feng Shui, Minimal, Natural, Shabby Chic)
Fondo 10x10 = 26 pzz
Fondo 20x20 = 11 pzz
Inserto Fabric 10x10 = 6 pzz
Inserto Fabric 20x20 = 6 pzz

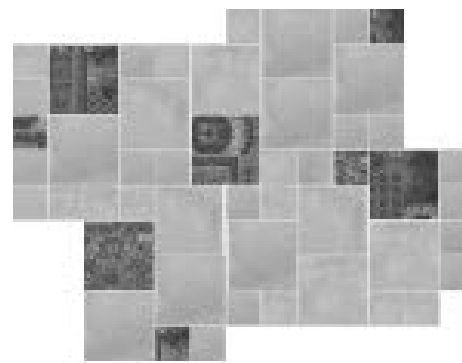

***MODULARE PATTERN**
(1 Mq Nominale)
Fondo 10x10 = 28 pzz
Fondo 20x20 = 13 pzz
Inserto 10x10 s/4 = 4 pzz
Inserto 20x20 s/4 = 4 pzz

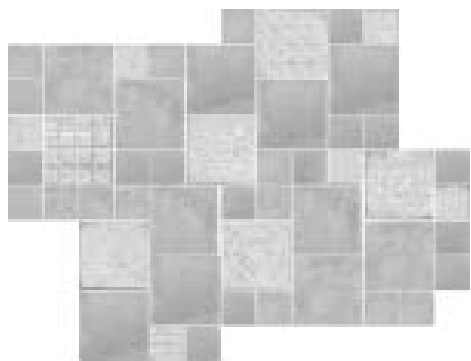

***MODULARE MAJOLICA**
(1 Mq Nominale)
Fondo 10x10 = 26 pzz
Fondo 20x20 = 11 pzz
Inserto 10x10 s/6 = 6 pzz
Inserto 20x20 s/6 = 6 pzz

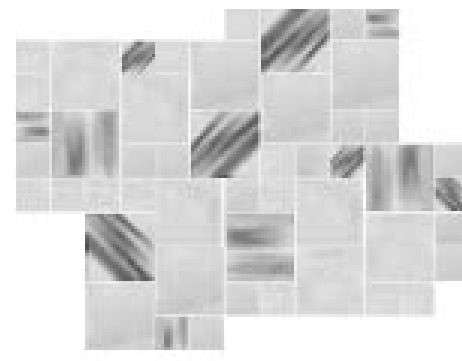

***MODULARE BRUSH**
(1 Mq Nominale)
Fondo 10x10 = 26 pzz
Fondo 20x20 = 11 pzz
Inserto 10x10 A+B = 6 pzz
Inserto 20x20 A+B = 6 pzz

*Per il prezzo del modulare richiedere il preventivo in azienda. *For the price of the modular pattern please ask for a quotation to the company.

*Veuillez demander au service commercial le préventif du modulaire. *Fuer den Modulpreis bitte im Werk anfragen.

*Цену для модульной укладки можно узнать на фабрике.

Schemi di Posa Modulare . Modular Laying Sketch. Schémas de Pose Modulaire. Modulverlegungsbeispiele.

MODULARE 28

2 - 10x10...7,72%
3 - 20x20...30,76%
4 - 20x40...61,52%

FONDO: 1° SCELTA MQ € 48,00

A: DECORO FABRIC (10x10-20x20): 1° SCELTA MQ € 51,00
B: DECORO FABRIC (20x20): 1° SCELTA MQ € 50,00
C: DECORO FABRIC (10x10): 1° SCELTA MQ € 49,00

MODULARE 29

1 - 10x10...14,3%
2 - 10x20...28,6%
3 - 20x20...57,1%

FONDO: 1° SCELTA MQ € 51,00

A: DECORO FABRIC (10x10-20x20): 1° SCELTA MQ € 57,00
B: DECORO FABRIC (20x20): 1° SCELTA MQ € 56,00
C: DECORO FABRIC (10x10): 1° SCELTA MQ € 52,00

MODULARE 30

1 - 10x10...25%
2 - 10x20...25%
3 - 20x20...50%

FONDO: 1° SCELTA MQ € 51,00

A: DECORO FABRIC (10x10-20x20): 1° SCELTA MQ € 58,00
B: DECORO FABRIC (20x20): 1° SCELTA MQ € 56,00
C: DECORO FABRIC (10x10): 1° SCELTA MQ € 53,00

MODULARE 31

1 - 10x10...11,1%
2 - 10x20...44,45%
3 - 20x20...44,45%

FONDO: 1° SCELTA MQ € 52,00

A: DECORO FABRIC (10x10-20x20): 1° SCELTA MQ € 57,00
B: DECORO FABRIC (20x20): 1° SCELTA MQ € 56,00
C: DECORO FABRIC (10x10): 1° SCELTA MQ € 53,00

MODULARE 32

1 - 10x10...11,1%
2 - 10x20...44,45%
3 - 20x20...44,45%

FONDO: 1° SCELTA MQ € 52,00

A: DECORO FABRIC (10x10-20x20): 1° SCELTA MQ € 57,00
B: DECORO FABRIC (20x20): 1° SCELTA MQ € 56,00
C: DECORO FABRIC (10x10): 1° SCELTA MQ € 53,00

MODULARE 33

2 - 10x20...50%
3 - 20x20...50%

FONDO: 1° SCELTA MQ € 52,00

A: DECORO FABRIC (20x20): 1° SCELTA MQ € 57,00

MODULARE 34

1 - 10x10...20%
3 - 20x20...80%

FONDO: 1° SCELTA MQ € 49,00

A: DECORO FABRIC (10x10-20x20): 1° SCELTA MQ € 57,00
B: DECORO FABRIC (20x20): 1° SCELTA MQ € 55,00
C: DECORO FABRIC (10x10): 1° SCELTA MQ € 50,00

MODULARE 35

2 - 10x20...14,3%
3 - 20x20...28,6%
4 - 20x40...57,1%

FONDO: 1° SCELTA MQ € 49,00

A: DECORO FABRIC (20x20): 1° SCELTA MQ € 51,00

MODULARE 36

1 - 10x10...6,66%
2 - 10x20...13,34%
3 - 20x20...26,66%
4 - 20x40...53,33%

FONDO: 1° SCELTA MQ € 49,00







A: DECORO FABRIC (10x10-20x20): 1° SCELTA MQ € 52,00
B: DECORO FABRIC (20x20): 1° SCELTA MQ € 51,00
C: DECORO FABRIC (10x10): 1° SCELTA MQ € 50,00



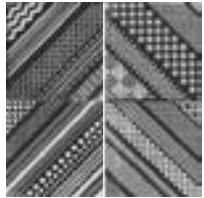
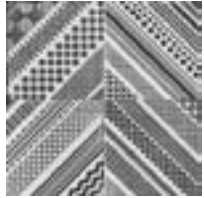

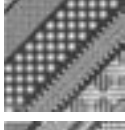

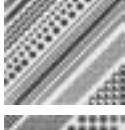
MODULARE 37

2 - 10x20...14,3%
3 - 20x20...28,6%
4 - 20x40...57,1%

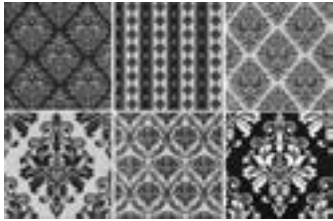

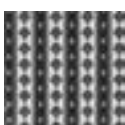

FONDO: 1° SCELTA MQ € 49,00

A: DECORO FABRIC (20x20): 1° SCELTA MQ € 51,00

FORMA&FORMATO SHAPE & SIZE FORME ET FORMAT FORM UND FORMAT		ARTICOLO ITEM ARTICLE ARTIKEL	1° SCELTA PREZZO SFUSO 1° CHOICE LOOSE PRICE 1 CHOIX PRIX EN VRAC 1 WAHL PREIS LOSE € . mq	COMM. PREZZO SFUSO COMM. LOOSE PRICE COMM. PRIX EN VRAC HW PREIS LOSE € . mq		Pz x Box	Mq x Box	Kg x Box	Box x Pall.	Mq x Pall.	Kg x Pall.
 20x20 ± 10 mm		SAN BABILA MIX* *I soggetti sono miscelati casualmente nelle scatole. *The subjects are randomly mixed in the box. *Les sujets sont mélangés de façon aléatoire dans les boites. *Die Dekore sind zufaellig im Karton gemischt. *Плитка с разными рисунками аккуратно перемешана внутри коробок.	56,00 56,00	26,00 26,00		Imballaggio SFUSO LOOSE EN VRAC LOSE 20x20					
						26	1,04	21,00	54	56,16	1.150
 20x20 ± 10 mm		ZONA BRERA MIX* *I soggetti sono miscelati casualmente nelle scatole. *The subjects are randomly mixed in the box. *Les sujets sont mélangés de façon aléatoire dans les boites. *Die Dekore sind zufaellig im Karton gemischt. *Плитка с разными рисунками аккуратно перемешана внутри коробок.	56,00 56,00	26,00 26,00		Imballaggio SFUSO LOOSE EN VRAC LOSE 20x20					
						26	1,04	21,00	54	56,16	1.150
FORMA SHAPE FORME FORM	FORMATO SIZE FORMAT FORMAT	ARTICOLO ITEM ARTICLE ARTIKEL	1° SCELTA PREZZO SFUSO 1° CHOICE LOOSE PRICE 1 CHOIX PRIX EN VRAC 1 WAHL PREIS LOSE € . mq	1° SCELTA PREZZO SFUSO 1° CHOICE LOOSE PRICE 1 CHOIX PRIX EN VRAC 1 WAHL PREIS LOSE € . pz	PZZ. PER SCAT. PCS PER BOX PCS PER BOÎTE ST. PRO KARTON	VERSIONE DI COLORE VERSION OF COLOUR VERSION COULEUR FARBEAUSFÜHRUNG					
		DECORAZIONI Decorations - Décors - Dekorationen			PZZ. PER SCAT. PCS PER BOX PCS PER BOÎTE ST. PRO KARTON 26 pzz.						
	20x20	San Babila Interno 101	66,00	3,00	4	Unica - Sole version - Unique Einzige Ausführung (Bianca su fondo nero)					
	20x20	San Babila Interno 102	66,00	3,00	4						
	20x20	San Babila Interno 103	66,00	3,00	4						
	20x20	San Babila Interno 104	66,00	3,00	4						
	20x20	Zona Brera Interno 101	66,00	3,00	4	Unica - Sole version - Unique Einzige Ausführung (Nera su fondo bianco)					
	20x20	Zona Brera Interno 102	66,00	3,00	4						
	20x20	Zona Brera Interno 103	66,00	3,00	4						
	20x20	Zona Brera Interno 104	66,00	3,00	4						

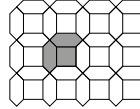
FORMA&FORMATO SHAPE & SIZE FORME ET FORMAT FORM UND FORMAT		ARTICOLO ITEM ARTICLE ARTIKEL	1° SCELTA PREZZO SFUSO 1° CHOICE LOOSE PRICE 1 CHOIX PRIX EN VRAC 1 WAHL PREIS LOSE € . mq	COMM. PREZZO SFUSO COMM. LOOSE PRICE COMM. PRIX EN VRAC HW PREIS LOSE € . mq		Pz x Box	Mq x Box	Kg x Box	Box x Pall.	Mq x Pall.	Kg x Pall.
 20x20 ± 10 mm		PIAZZA DI SPAGNA MIX* <small>*I soggetti sono miscelati casualmente nelle scatole. *The subjects are randomly mixed in the box. *Les sujets sont mélangés de façon aléatoire dans les boîtes. *Die Dekore sind zufaellig im Karton gemischt. *Плитка с разными рисунками аккуратно перемешана внутри коробок.</small>	56,00	33,00		Imballaggio SFUSO LOOSE EN VRAC LOSE 20x20					
						26	1,04	21,00	54	56,16	1.150
FORMA SHAPE FORME FORM	FORMATO SIZE FORMAT FORMAT	ARTICOLO ITEM ARTICLE ARTIKEL	1° SCELTA PREZZO SFUSO 1° CHOICE LOOSE PRICE 1 CHOIX PRIX EN VRAC 1 WAHL PREIS LOSE € . mq	1° SCELTA PREZZO SFUSO 1° CHOICE LOOSE PRICE 1 CHOIX PRIX EN VRAC 1 WAHL PREIS LOSE € . pz	PZZ. PER SCAT. PCS PER BOX PCS PER BOÎTE ST. PRO KARTON	VERSIONE DI COLORE VERSION OF COLOUR VERSION COULEUR FARBEAUSFÜHRUNG					
		DECORAZIONI Decorations - Décors - Dekorationen			PZZ. PER SCAT. PCS PER BOX PCS PER BOÎTE ST. PRO KARTON 26 pzz.						
	20x20	Via Frattina	66,00	3,00	4	Bianco/Nero					
	20x20	Via Condotti	66,00	3,00	4	Bianco/Nero					
	20x20	Via Sistina	66,00	3,00	4	Unica - Sole version - Unique Einzig Ausführung					
	20x20	Via Margutta	66,00	3,00	4	Unica - Sole version - Unique Einzig Ausführung					
	7,5x20	Listello Via Margutta		5,00	6						

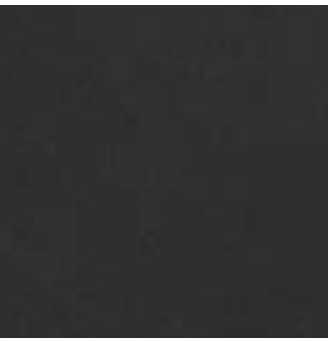
FORMA&FORMATO SHAPE & SIZE FORME ET FORMAT FORM UND FORMAT		ARTICOLO ITEM ARTICLE ARTIKEL	1° SCELTA PREZZO SFUSO 1° CHOICE LOOSE PRICE 1 CHOIX PRIX EN VRAC 1 WAHL PREIS LOSE € . mq	COMM. PREZZO SFUSO COMM. LOOSE PRICE COMM. PRIX EN VRAC HW PREIS LOSE € . mq		Pz x Box	Mq x Box	Kg x Box	Box x Pall.	Mq x Pall.	Kg x Pall.
 20x20 ± 10 mm		PROGETTO BIANCO PROGETTO NERO	42,00 42,00	25,00 25,00		Imballaggio SFUSO LOOSE EN VRAC LOSE 20x20					
		PROGETTO BIANCO LAPPATO PROGETTO NERO LAPPATO	66,00 66,00	40,00 40,00		26	1,04	21,00	54	56,16	1.150
						Imballaggio SFUSO LOOSE EN VRAC LOSE 20x20 LAPPATO					
						25	1,00	20,20	54	54,00	1.107

FORMA&FORMATO SHAPE & SIZE FORME ET FORMAT FORM UND FORMAT	ARTICOLO ITEM ARTICLE ARTIKEL	1° SCELTA PREZZO SFUSO <small>1° CHOICE LOOSE PRICE</small> <small>1 CHOIX PRIX EN VRAC</small> <small>1 WAHL PREIS LOSE</small> € . mq	COMM. PREZZO SFUSO <small>COMM. LOOSE PRICE</small> <small>COMM. PRIX EN VRAC</small> <small>HW PREIS LOSE</small> € . mq		Pz x Box	Mq x Box	Kg x Box	Box x Pall.	Mq x Pall.	Kg x Pall.		
 14x34 Losanga lato 20 ϕ 10 mm	LOSANGA BIANCO LOSANGA BORDEAUX LOSANGA CREMA LOSANGA GRIGIO LOSANGA NERO LOSANGA TORTORA	62,00 62,00 62,00 62,00 62,00 62,00	36,00 36,00 36,00 36,00 36,00 36,00		Pz x Box	Mq x Box	Kg x Box	Box x Pall.	Mq x Pall.	Kg x Pall.		
					Imballaggio SFUSO LOOSE EN VRAC LOSE 14x34							
					20	0,77	15,00	44	33,88	676		
					 MODULO LOSANGA LOSANGA LATO 20 = 65,40% 20x20 = 34,60%							
 20x60,8 ϕ 10 mm	AZZURRO BIANCO BLU BORDEAUX CAMOSCIO CREMA GIALLO GRIGIO NERO TORTORA VERDE	52,00 52,00 52,00 52,00 52,00 52,00 52,00 52,00 52,00 52,00	31,00 31,00 31,00 31,00 31,00 31,00 31,00 31,00 31,00 31,00		Pz x Box	Mq x Box	Kg x Box	Box x Pall.	Mq x Pall.	Kg x Pall.		
	Imballaggio SFUSO LOOSE EN VRAC LOSE 20x60,8											
	9	1,09	23,00		48	52,32	1.120					
	Pz x Box	Mq x Box	Kg x Box		Box x Pall.	Mq x Pall.	Kg x Pall.					
	Imballaggio SFUSO LOOSE EN VRAC LOSE 20x60,8											
	9	1,09	23,00		48	52,32	1.120					
	 60,8x60,8 ϕ 10 mm	BORDEAUX CREMA GRIGIO NERO TORTORA	50,00 50,00 50,00 50,00 50,00		28,00 28,00 28,00 28,00 28,00		Pz x Box	Mq x Box	Kg x Box	Box x Pall.	Mq x Pall.	Kg x Pall.
							Imballaggio SFUSO LOOSE EN VRAC LOSE 60,8x60,8					
							3	1,11	26,00	32	35,52	848
	 BATTISCOPIA 8x60,8	AZZURRO BIANCO BLU BORDEAUX CAMOSCIO CREMA GIALLO GRIGIO NERO TORTORA VERDE	15,00 15,00 15,00 15,00 15,00 15,00 15,00 15,00 15,00 15,00		9,00 9,00 9,00 9,00 9,00 9,00 9,00 9,00 9,00 9,00	€ . ml	Pz x Box	MI x Box	Kg x Box	Box x Pall.	MI x Pall.	Kg x Pall.
							Imballaggio SFUSO LOOSE EN VRAC LOSE Battiscopa 8x60,8					
							20	12,16	13,00	50	608	666

CASSETTONE VIAEMILIA*	CASSETTONE VIAEMILIA 1	CASSETTONE VIAEMILIA 2	CASSETTONE VIAEMILIA 3	CASSETTONE VIAEMILIA 4
<p>cassettoni composti da: 60,8x60,8 = 56,62% 20x60,8 = 37,25% 20x20 = 6,13%</p>	60,8x60,8 NAT 20x60,8 NAT 20x20 NAT 	60,8x60,8 NAT 20x60,8 NAT 20x20 LAPP 	60,8x60,8 NAT 20x60,8 LAPP 20x20 NAT 	60,8x60,8 NAT 20x60,8 LAPP 20x20 LAPP

*È possibile comporre il cassettoni combinando colori, superfici e decori disponibili nei formati 20x20, 20x60,8 e 60,8x60,8 della serie ViaEmilia.

*Possibility to create the "cassettoni" combining colors, surfaces and sizes of Via Emilia in 20x20, 20x60,8 and 60,8x60,8.

*Il est possible de créer le "carré-navette" en utilisant couleurs, surfaces et décors disponibles dans les formats 20x20, 20x60,8 et 60,8x60,8 de la série ViaEmilia.





*Bei der Serie Via Emilia kann man den "Cassettoni" mit verschiedenen Farben, Oberflächen oder Dekoren kombinieren mit den Formaten 20x20 20x60,8 60,8x60,8.

FORMA SHAPE FORME FORM	FORMATO SIZE FORMAT FORMAT	ARTICOLO ITEM ARTICLE ARTIKEL	1° SCELTA PREZZO SFUSO 1° CHOICE LOOSE PRICE 1 WAHL PREIS LOSE	1° SCELTA PREZZO SFUSO 1° CHOICE LOOSE PRICE 1 WAHL PREIS LOSE	PZZ. PER SCAT. PCS PER BOX PCS PER BOÎTE ST. PRO KARTON	VERSIONE DI COLORE VERSION OF COLOUR VERSION COULEUR FARBEAUSFÜHRUNG
		DECORAZIONI Decorations - Décors - Dekorationen	€ . mq	€ . pz		
			PZZ. PER SCAT. PCS PER BOX PCS PER BOÎTE ST. PRO KARTON 25 pzz.			
	20x20 20x20 20x20 10x20 10x10 10x10 24x24 14x34	Inserto Mauriziano Greca Mauriziano Angolo Greca Mauriziano Fascia Mauriziano Angolo Fascia Mauriziano Inserto Mauriziano Ottagona lato 10 Mauriziano Losanga lato 20 Mauriziano	190,00 190,00 190,00	11,00 11,00 12,00 11,00 11,00 10,00	4 4 4 4 4 4 4 4	Tortora (camoscio, giallo e nero su base tortora) Crema (camoscio, nero e verde su base crema)
	20x20 20x20 20x20 20x20 20x20 10x20 10x10 10x10 10x10 24x24 14x34	Inserto ViaEmilia Greca ViaEmilia Linea Angolo Greca ViaEmilia Linea Greca ViaEmilia Festone Angolo Greca ViaEmilia Festone Fascia ViaEmilia Angolo Fascia ViaEmilia Inserto ViaEmilia Esagono Inserto ViaEmilia Festone Ottagona lato 10 ViaEmilia Losanga lato 20 ViaEmilia	190,00 190,00 190,00 190,00 190,00	11,00 11,00 12,00 11,00 12,00 11,00 11,00 10,00 10,00	4 4 4 4 4 4 4 4 4 4 4	Crema-Azzurro (azzurro, camoscio e tortora su base crema) Bianco-Blu (blu, giallo e grigio su base bianca) Bianco-Bordeaux (blu, bordeaux e grigio su base bianca)
	20x20 20x20 20x20 20x20 20x60,8 10x20 10x10 10x10 10x10 10x10 24x24 14x34	Inserto Rivalta Fiore Inserto Rivalta Quadro Greca Rivalta Fiore Angolo Greca Rivalta Fiore Greca Righe Fascia Rivalta Angolo Fascia Rivalta Inserto Rivalta Fiore Inserto Rivalta Quadro Ottagona lato 10 Rivalta Losanga lato 20 Rivalta	190,00 190,00 190,00 190,00	11,00 11,00 11,00 12,00 32,00 11,00 11,00 10,00 10,00 10,00	4 4 4 4 4 4 4 4 4 4 4 4	Crema (azzurro, camoscio e giallo su base crema) Grigio (bordeaux, camoscio e nero su base grigia) Tortora (camoscio, nero e verde su base tortora)
	20x20 20x20 20x60,8 24x24 14x34	Inserto Canali s/6 Inserto Canali s/6 lappato Greca Righe Ottagona lato 10 Canali Losanga lato 20 Canali	190,00* 440,00*	11,00 21,00 32,00	6 6 4	Grigio (bordeaux, grigio e nero su base grigia)
	20x20 10x20 10x10	Inserto Italia Fascia Italia Angolo Fascia Italia	190,00	11,00 11,00 11,00	4 4 4	Tortora (azzurro e camoscio su base tortora) Crema (bordeaux e grigio su base crema) Grigio (bianco e nero su base grigia)
	5x20 5x3	London Via Emilia Angolo London Via Emilia		10,00 15,00	12 4	Azzurro/Blu/Bordeaux/Camoscio Giallo/Nero/Verde
	2,5x20	Sigaro Via Emilia		9,00	24	Azzurro/Blu/Bordeaux/Camoscio Giallo/Nero/Verde

*PZZ. PER SCAT. - PCS PER BOX - PCS PER BOX - ST. PRO KARTON: PZZ. 24
 **PZZ. PER SCAT. - PCS PER BOX - PCS PER BOX - ST. PRO KARTON: PZZ. 20

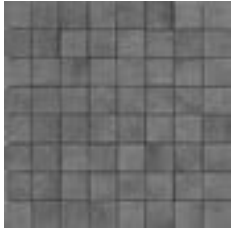
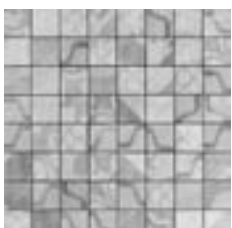
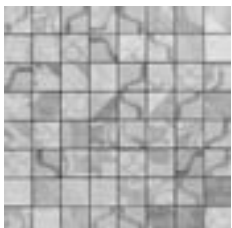
FORMA SHAPE FORME FORM	FORMATO SIZE FORMAT FORMAT	ARTICOLO ITEM ARTICLE ARTIKEL	1° SCELTA PREZZO SFUSO 1° CHOICE LOOSE PRICE 1 CHOIX PRIX EN VRAC 1 WAHL PREIS LOSE € . mq		PZZ. PER SCAT. PCS PER BOX PCS PER BOÎTE ST. PRO KARTON	VERSIONE DI COLORE VERSION OF COLOUR VERSION COULEUR FARBEAUSFÜHRUNG	
		DECORAZIONI Decorations - Décors - Dekorationen					
	60,8x60,8	Trama Mauriziano	175,00		2	Tortora	
	60,8x60,8	Inserto Mauriziano (Comp. 4 pezzi, 121,6x121,6)	190,00		2		
	60,8x60,8	Inserto Itala	190,00		2	Crema/Grigio	
	60,8x60,8	Trama Rivalta Fiore	190,00		2	Crema/Grigio	
	60,8x60,8	Inserto Rivalta Fiore	175,00		2		
	60,8x60,8	Inserto Canali Cerchi	190,00		2	Bordeaux/Grigio/Nero	
	60,8x60,8	Inserto Canali Cerchi <i>lappato</i>	280,00		2	Grigio/Nero	
	60,8x60,8	Inserto Canali Fiore	190,00		2	Bordeaux/Grigio/Nero	
	60,8x60,8	Inserto Canali Fiore <i>lappato</i>	280,00		2	Grigio/Nero	
FORMA SHAPE FORME FORM	ARTICOLO ITEM ARTICLE ARTIKEL	1° SCELTA PREZZO SFUSO 1° CHOICE LOOSE PRICE 1 CHOIX PRIX EN VRAC 1 WAHL PREIS LOSE € . pz	PZZ. PER SCAT. PCS PER BOX PCS PER BOÎTE ST. PRO KARTON	FORMA SHAPE FORME FORM	ARTICOLO ITEM ARTICLE ARTIKEL	1° SCELTA PREZZO SFUSO 1° CHOICE LOOSE PRICE 1 CHOIX PRIX EN VRAC 1 WAHL PREIS LOSE € . pz	PZZ. PER SCAT. PCS PER BOX PCS PER BOÎTE ST. PRO KARTON
	PEZZI SPECIALI Special pieces - Pièces spéciales Spezielle Stücke				PEZZI SPECIALI Special pieces - Pièces spéciales Spezielle Stücke		
	Torello 1	22,00	2		Battistraccio 2 linea	22,00	2
	Spigolo 3	24,00	1		Battistraccio 5 Angolo	24,00	1
	Angolo 6 (dx-sx)	24,00	2		Battistraccio 4 (sx)	24,00	1
					Battistraccio 4 (dx)	24,00	1
Disponibili nei colori: - Available in the version of colours: - Disponibles dans les couleurs: - In den Farben lieferbar: Bianco/Blu/Bordeaux/Camoscio/Crema/Giallo/Tortora							
	B.C. (Bullnose) 10x10	2,70	72		D.B.C. (Corner) 10x10	3,70	72
Disponibili in tutti i colori - Available in all colours - Disponibles dans toutes les couleurs - In allen Farben lieferbar							

FORMA&FORMATO SHAPE & SIZE FORME ET FORMAT FORM UND FORMAT		ARTICOLO ITEM ARTICLE ARTIKEL	1° SCELTA PREZZO SFUSO 1° CHOICE LOOSE PRICE 1 CHOIX PRIX EN VRAC 1 WAHL PREIS LOSE € . mq	COMM. PREZZO SFUSO COMM. LOOSE PRICE COMM. PRIX EN VRAC HW PREIS LOSE € . mq		Pz x Box	Mq x Box	Kg x Box	Box x Pall.	Mq x Pall.	Kg x Pall.
 48x48 ± 10 mm	 	COCCIO	42,00	27,00		Imballaggio SFUSO LOOSE EN VRAC LOSE 48x48					
		FANGO	42,00	27,00		5	1,15	24,70	28	32,20	708
		MALACHITE	42,00	27,00							
		ORZATA	42,00	27,00							
		POLVERE	42,00	27,00							
		TAMARINDO	42,00	27,00							
ZAFFERANO	42,00	27,00									
 BATTISCOPA 8x48		COCCIO	12,00			Pz x Box	MI x Box	Kg x Box	Box x Pall.	MI x Pall.	Kg x Pall.
		FANGO	12,00			Imballaggio SFUSO LOOSE EN VRAC LOSE Battiscopa 8x48					
		MALACHITE	12,00			15	7,20	12,10	54	388,8	670
		ORZATA	12,00								
		POLVERE	12,00								
		TAMARINDO	12,00								
ZAFFERANO	12,00										
FORMA SHAPE FORME FORM	FORMATO SIZE FORMAT FORMAT	ARTICOLO ITEM ARTICLE ARTIKEL	1° SCELTA PREZZO SFUSO 1° CHOICE LOOSE PRICE 1 CHOIX PRIX EN VRAC 1 WAHL PREIS LOSE € . mq	COMM. PREZZO SFUSO COMM. LOOSE PRICE COMM. PRIX EN VRAC HW PREIS LOSE € . mq	PZZ. PER SCAT. PCS PER BOX PCS PER BOÎTE ST. PRO KARTON	VERSIONE DI COLORE VERSION OF COLOUR VERSION COULEUR FARBEAUSFÜHRUNG					
		DECORAZIONI AL MQ Decorations - Décors - Dekorationen				Imballaggio SFUSO LOOSE EN VRAC LOSE 48x48					
						5	1,15	24,70	28	32,20	707,60
 	48x48	Insero Linda s/1	52,00	32,00	5	Orzata/Polvere					
	48x48	Insero Penelope s/1	52,00	32,00	5						
	48x48	Insero Luna s/1	52,00	32,00	5						
	48x48	Insero Apollo s/1	52,00	32,00	5	Tutti i colori - All colours					
	48x48	Insero Isotta s/1	52,00	32,00	5						
	48x48	Insero Olivia s/1	52,00	32,00	5	Malachite/Zafferano					
	48x48	Insero Aurora s/1	52,00	32,00	5	Malachite/Zafferano					

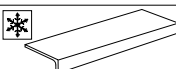
FORMA&FORMATO SHAPE & SIZE FORME ET FORMAT FORM UND FORMAT		ARTICOLO ITEM ARTICLE ARTIKEL	1° SCELTA PREZZO SFUSO 1° CHOICE LOOSE PRICE 1 CHOIX PRIX EN VRAC 1 WAHL PREIS LOSE			Pz x Box	Mq x Box	Kg x Box	Box x Pall.	Mq x Pall.	Kg x Pall.
		MOSAICI Mosaics - Mosaiques - Mosaiken	€ . foglio sheet/feuille/Blatt								
 MOSAICO ANNI '70 TESSERA 5,7x5,7 FOGLIO/SHEET/FEUILLE/BLATT 48x48		COCCIO 28,00 FANGO 28,00 MALACHITE 28,00 ORZATA 28,00 POLVERE 28,00 TAMARINDO 28,00 ZAFFERANO 28,00				3	0,678	13,50	20	13,56	286
 MOSAICO ANNI '70 MIX TESSERA 5,7x5,7 FOGLIO/SHEET/FEUILLE/BLATT 48x48		MIX COCCIO 30,00 MIX FANGO 30,00 MIX MALACHITE 30,00 MIX ORZATA 30,00 MIX POLVERE 30,00 MIX TAMARINDO 30,00 MIX ZAFFERANO 30,00				Pz x Box	Ml x Box	Kg x Box	Box x Pall.	Ml x Pall.	Kg x Pall.
						3	0,678	13,50	20	13,56	286
 MOSAICO ANNI '70 MIX DECORATO TESSERA 5,7x5,7 FOGLIO/SHEET/FEUILLE/BLATT 48x48		MIX AURORA/OLIVIA composto da: Inserto Olivia malachite e zafferano, Inserto Aurora malachite e zafferano	32,00			Pz x Box	Ml x Box	Kg x Box	Box x Pall.	Ml x Pall.	Kg x Pall.
						3	0,678	13,50	20	13,56	286
FORMA SHAPE FORME FORM	FORMATO SIZE FORMAT FORMAT	ARTICOLO ITEM ARTICLE ARTIKEL	1° SCELTA PREZZO SFUSO 1° CHOICE LOOSE PRICE 1 CHOIX PRIX EN VRAC 1 WAHL PREIS LOSE		PZZ. PER SCAT. PCS PER BOX PCS PER BOÎTE ST. PRO KARTON	VERSIONE DI COLORE VERSION OF COLOUR VERSION COULEUR FARBEAUSFÜHRUNG					
		DECORAZIONI Decorations - Décors - Dekorationen									
	11,5x48 11,5x11,5	Fascia Anni '70 Tozzetto Anni '70 s/4	24,00 9,00		4 4	Orzata/Polvere					
	11,5x48 11,5x11,5	Fascia Bubble Tozzetto Bubble s/4	24,00 9,00		4 4	Orzata/Polvere					
	3,5x100	Cornice Anni '70	32,00		4	Grigia					
FORMA SHAPE FORME FORM	ARTICOLO ITEM ARTICLE ARTIKEL	1° SCELTA PREZZO SFUSO 1° CHOICE LOOSE PRICE 1 CHOIX PRIX EN VRAC 1 WAHL PREIS LOSE	PZZ. PER SCAT. PCS PER BOX PCS PER BOÎTE ST. PRO KARTON	KG PER SCAT. KG FOR BOX KG PAR BOÎTE KG PRO KARTON	SCAT.PER PALLET BOXES FOR PALLET BOÎTES PAR PALETTE KARTONS PRO PALETTE	KG PER PALLET KG FOR PALLET KG PAR PALETTE KG PRO PALETTE					
	PEZZI SPECIALI Special pieces - Pièces spéciales Spezielle Stücke										
	Elemento ad "L" 15x48x5	25,00	4	6,00	40	256	Disponibili in tutti i colori Available in all colours Disponibles dans toutes les couleurs In allen Farben lieferbar				

FORMA&FORMATO SHAPE & SIZE FORME ET FORMAT FORM UND FORMAT		ARTICOLO ITEM ARTICLE ARTIKEL	1° SCELTA PREZZO SFUSO 1° CHOICE LOOSE PRICE 1 CHOIX PRIX EN VRAC 1 WAHL PREIS LOSE	COMM. PREZZO SFUSO COMM. LOOSE PRICE COMM. PRIX EN VRAC HW PREIS LOSE	Pz x Box	Mq x Box	Kg x Box	Box x Pall.	Mq x Pall.	Kg x Pall.
 8,6x35 ± 10 mm	 	COVENT GARDEN (beige)	54,00	32,00	Imballaggio SFUSO LOOSE EN VRAC LOSE					
		LONDON (rosso)	54,00	32,00	8,6x35					
		NOTTING HILL (gesso)	54,00	32,00	20	0,602	12,50	84	50,57	1.066
		PICCADILLY (rosato)	54,00	32,00						
		REGENT STREET (grigio)	54,00	32,00						
 8,6x26,2 ± 10 mm	 	COVENT GARDEN (beige)	54,00	32,00	Imballaggio SFUSO LOOSE EN VRAC LOSE					
		LONDON (rosso)	54,00	32,00	8,6x26,2					
		NOTTING HILL (gesso)	54,00	32,00	19	0,428	9,00	119	50,94	1.087
		PICCADILLY (rosato)	54,00	32,00						
		REGENT STREET (grigio)	54,00	32,00						
 8,6x8,6 ± 10 mm	 	COVENT GARDEN (beige)	54,00	32,00	Imballaggio SFUSO LOOSE EN VRAC LOSE					
		LONDON (rosso)	54,00	32,00	8,6x8,6					
		NOTTING HILL (gesso)	54,00	32,00	57	0,422	9,00	68	28,70	628
		PICCADILLY (rosato)	54,00	32,00						
		REGENT STREET (grigio)	54,00	32,00						
FORMA SHAPE FORME FORM	FORMATO SIZE FORMAT FORMAT	ARTICOLO ITEM ARTICLE ARTIKEL	1° SCELTA PREZZO SFUSO 1° CHOICE LOOSE PRICE 1 CHOIX PRIX EN VRAC 1 WAHL PREIS LOSE	PZZ. PER SCAT. PCS PER BOX PCS PER BOÎTE ST. PRO KARTON	VERSIONE DI COLORE VERSION OF COLOUR VERSION COULEUR FARBBAUSFÜHRUNG					
		DECORAZIONI** Decorations - Décors - Dekorationen	€ . pz							
	8,6x35	Inserto Streets s/6	9,00	6	Tutti i colori - All colours					
FORMA SHAPE FORME FORM	ARTICOLO ITEM ARTICLE ARTIKEL	1° SCELTA PREZZO SFUSO 1° CHOICE LOOSE PRICE 1 CHOIX PRIX EN VRAC 1 WAHL PREIS LOSE	PZZ. PER SCAT. PCS FOR BOX PCS PAR BOÎTE ST. PRO KARTON	KG PER SCAT. KG FOR BOX KG PAR BOÎTE KG PRO KARTON	SCAT.PER PALLET BOXES FOR PALLET BOÎTES PAR PALETTE KARTONS PRO PALETTE	KG PER PALLET KG FOR PALLET KG PAR PALETTE KG PRO PALETTE				
	PEZZI SPECIALI Special pièces - Pièces spéciales Spezielle Stücke	€ . pz								
	Elemento ad "L" 8,6x11x15 (vedi applicazioni elemento "L") ("L" shaped trim piece) (utilisations de l'élément "à L") (Verlegebeispiele der Schenkel)	8,00	12	5,64	72	422				
Disponibili in tutti i colori - Available in all colours Disponibles dans toutes les couleurs - In allen Farben lieferbar										

APPLICAZIONI ELEMENTO AD "L". "L" SHAPED TRIM PIECE. UTILISATIONS DE L'ÉLÉMENT "À L". VERLEGEBEISPIELE DER SCHENKEL.

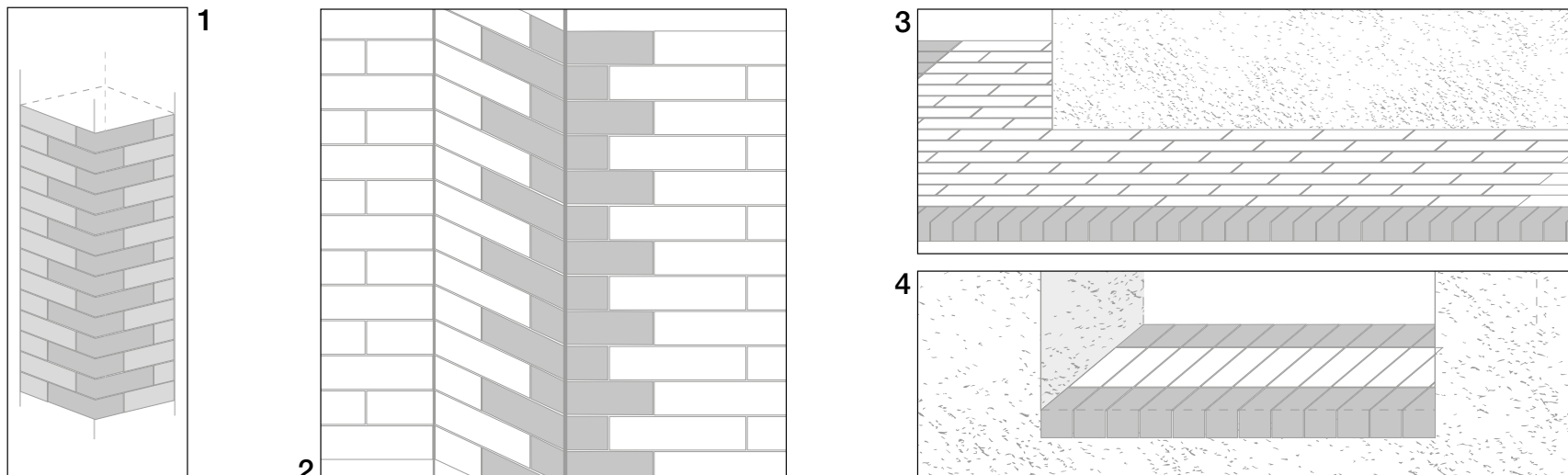

FORMA&FORMATO SHAPE & SIZE FORME ET FORMAT FORM UND FORMAT		ARTICOLO ITEM ARTICLE ARTIKEL	1° SCELTA PREZZO SFUSO 1° CHOICE LOOSE PRICE 1 CHOIX PRIX EN VRAC 1 WAHL PREIS LOSE	COMM. PREZZO SFUSO COMM. LOOSE PRICE COMM. PRIX EN VRAC HW PREIS LOSE	Pz x Box	Mq x Box	Kg x Box	Box x Pall.	Mq x Pall.	Kg x Pall.
<p>8,6x35 ± 10 mm</p>		BLACK LINE (nero)	54,00	32,00	20	0,602	12,50	84	50,57	1.066
		BLUE LINE (blu)	54,00	32,00						
		RED LINE (rosso)	54,00	32,00						
		VIOLET LINE (viola)	54,00	32,00						
		WHITE LINE (bianco)	54,00	32,00						
<p>8,6x26,2 ± 10 mm</p>		BLACK LINE (nero)	54,00	32,00	19	0,428	9,00	119	50,94	1.087
		BLUE LINE (blu)	54,00	32,00						
		RED LINE (rosso)	54,00	32,00						
		VIOLET LINE (viola)	54,00	32,00						
		WHITE LINE (bianco)	54,00	32,00						
<p>8,6x8,6 ± 10 mm</p>		BLACK LINE (nero)	54,00	32,00	57	0,422	9,00	68	28,70	628
		BLUE LINE (blu)	54,00	32,00						
		RED LINE (rosso)	54,00	32,00						
		VIOLET LINE (viola)	54,00	32,00						
		WHITE LINE (bianco)	54,00	32,00						
FORMA SHAPE FORME FORM	FORMATO SIZE FORMAT FORMAT	ARTICOLO ITEM ARTICLE ARTIKEL	1° SCELTA PREZZO SFUSO 1° CHOICE LOOSE PRICE 1 CHOIX PRIX EN VRAC 1 WAHL PREIS LOSE	PZZ. PER SCAT. PCS PER BOX PCS PER BOÎTE ST. PRO KARTON	VERSIONE DI COLORE VERSION OF COLOUR VERSION COULEUR FARBEAUSFÜHRUNG					
		DECORAZIONI** Decorations - Décors - Dekorationen	€ . pz							
	8,6x35	Inserto Streets s/6	9,00	6	Black/Blue/Red/Violet/White					
	8,6x35	Inserto Underground	10,00	6	Black/White					
	8,6x35	Inserto London	10,00	6	Black/White					
FORMA SHAPE FORME FORM	ARTICOLO ITEM ARTICLE ARTIKEL	1° SCELTA PREZZO SFUSO 1° CHOICE LOOSE PRICE 1 CHOIX PRIX EN VRAC 1 WAHL PREIS LOSE	PZZ. PER SCAT. PCS PER BOX PCS PER BOÎTE ST. PRO KARTON	KG PER SCAT. KG FOR BOX KG PAR BOÎTE KG PRO KARTON	SCAT. PER PALLET BOXES FOR PALLET BOÎTES PAR PALETTE KARTONS PRO PALETTE	KG PER PALLET KG FOR PALLET KG PAR PALETTE KG PRO PALETTE				
	PEZZI SPECIALI Special pieces - Pièces spéciales Spezielle Stücke	€ . pz								
	Elemento ad "L" 8,6x11x15 (vedi applicazioni elemento "L") ("L" shaped trim piece) (utilisations de l'élément "à L") (Verlegebeispiele der Schenkel)	8,00	12	5,64	72	422				
Disponibile nel colore: - Available in the version of colours: Disponible dans les couleur: - In den Farben lieferbar: White										

SCHEMI DI POSA. INSTALLATION LAYING. SCHÉMAS DE POSE. VERLEGUNGSVORSCHLÄGE.

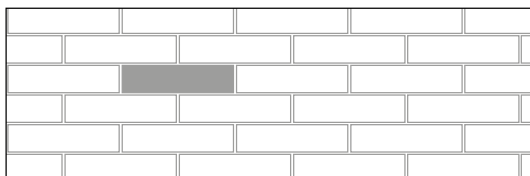

1
8,6x35= 100%

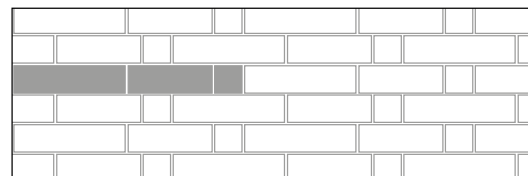

3
8,6x35= 50%
8,6x26,2=37,50%
8,6x8,6= 12,50%

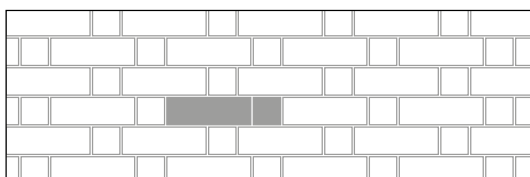

2
8,6x26,2=75%
8,6x8,6= 25%

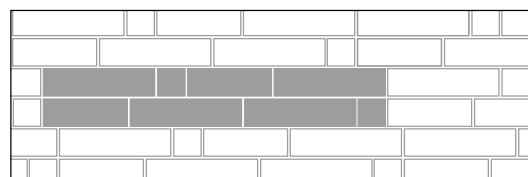

4
8,6x35= 66,7%
8,6x26,2=25%
8,6x8,6= 8,3%

FORMA&FORMATO SHAPE & SIZE FORME ET FORMAT FORM UND FORMAT		ARTICOLO ITEM ARTICLE ARTIKEL	1° SCELTA PREZZO SFUSO 1° CHOICE LOOSE PRICE 1 WAHL PREIS EN VRAC 1 WAHL PREIS LOSE	COMM. PREZZO SFUSO COMM. LOOSE PRICE COMM. PRIX EN VRAC HW PREIS LOSE	1° SCELTA PREZZO RETE 1° CHOICE NET PRICE 1 CHOIX PRIX SUR FILET 1 WAHL PREIS NETZ	Pz x Box	Mq x Box	Kg x Box	Box x Pall.	Mq x Pall.	Kg x Pall.	
 10x10 ± 11 mm	 	FUMÉE IVOIRE LILAS NOIR NOISETTE ORANGE ROUGE VIOLETTE	48,00	29,00	52,00	Imballaggio SFUSO LOOSE EN VRAC LOSE 10x10						
			48,00	29,00	52,00	68	0,68	14,90	72	48,96	1.089	
						Imballaggio RETE 30x40 9 Fogli Net 30x40 9 Sheets - Net 30x40 9 Feuille - Netz Blatt 30x40 9 Blätter 10x10						
						108	1,15	23,80	48	55,20	1.158	
 20x20 ± 11 mm	 	FUMÉE IVOIRE LILAS NOIR NOISETTE ORANGE ROUGE VIOLETTE	42,00	25,00		Pz x Box	Mq x Box	Kg x Box	Box x Pall.	Mq x Pall.	Kg x Pall.	
			42,00	25,00		Imballaggio SFUSO LOOSE EN VRAC LOSE 20x20						
						24	0,96	20,60	54	51,84	1.128	
 31,7x31,7 ± 11 mm	 	FUMÉE IVOIRE LILAS NOIR NOISETTE ORANGE ROUGE VIOLETTE	37,00	22,00		Pz x Box	Mq x Box	Kg x Box	Box x Pall.	Mq x Pall.	Kg x Pall.	
			37,00	22,00		Imballaggio SFUSO LOOSE EN VRAC LOSE 31,7x31,7						
						10	1,005	21,80	48	48,24	1.062	
 BATTISCOPA 8x31,7	 	FUMÉE IVOIRE LILAS NOIR NOISETTE ORANGE ROUGE VIOLETTE	11,00			Imballaggio SFUSO LOOSE EN VRAC LOSE BATTISCOPA 8x31,7						
			11,00			Pz x Box	Ml x Box	Kg x Box	Box x Pall.	Ml x Pall.	Kg x Pall.	
						30	9,51	11,60	48	456,48	573	
MOSAICI Mosaics - Mosaïques - Mosaiken			€ . foglio sheet/feuille/Blatt									
 SPACCATELLA MIX FOGLIO/SHEET/FEUILLE/BLATT 30x30	 	MIX BEIGE Composto da: Ivoire, Noisette, Fumée	18,00			Pz x Box	Mq x Box	Kg x Box	Box x Pall.	Mq x Pall.	Kg x Pall.	
		MIX GRIGIO Composto da: Ivoire, Fumée, Noir	18,00			5	0,45	10	60	27	616	
		MIX COTTO Composto da: Ivoire, Orange, Rouge	18,00									
		MIX VIOLA Composto da: Fumée, Lilas, Violette	18,00									
FORMA SHAPE FORME FORM	FORMATO SIZE FORMAT FORMAT	ARTICOLO ITEM ARTICLE ARTIKEL	1° SCELTA PREZZO SFUSO 1° CHOICE LOOSE PRICE 1 CHOIX PRIX EN VRAC 1 WAHL PREIS LOSE	1° SCELTA PREZZO SFUSO 1° CHOICE LOOSE PRICE 1 CHOIX PRIX EN VRAC 1 WAHL PREIS LOSE	PZZ. PER SCAT. PCS PER BOX PCS PER BOÎTE ST. PRO KARTON	VERSIONE DI COLORE VERSION OF COLOUR VERSION COULEUR FARBEAUSFÜHRUNG						
DECORAZIONI Decorations - Décors - Dekorationen												
 10x31,7		Fascia Spaccatella Mix	ml	34,00	10	Mix Beige (Ivoire, Noisette, Fumée) Mix Grigio (Ivoire, Fumée, Noir) Mix Cotto (Ivoire, Orange, Rouge) Mix Viola (Fumée, Lilas, Violette)						
	 10x10 5x20		Inserto Vogue s/3 Listello Vogue		15,00 13,00	6 8	Cotto/Viola Beige/Cotto/Viola					

FORMA SHAPE FORME FORM	FORMATO SIZE FORMAT FORMAT	ARTICOLO ITEM ARTICLE ARTIKEL	1° SCELTA PREZZO SFUSO 1° CHOICE LOOSE PRICE 1 CHOIX PRIX EN VRAC 1 WAHL PREIS LOSE € . mq	1° SCELTA PREZZO SFUSO 1° CHOICE LOOSE PRICE 1 CHOIX PRIX EN VRAC 1 WAHL PREIS LOSE € . pz	PZZ. PER SCAT. PCS PER BOX PCS PER BOÎTE ST. PRO KARTON	VERSIONE DI COLORE VERSION OF COLOUR VERSION COULEUR FARBEAUSFÜHRUNG
		DECORAZIONI Decorations - Décors - Dekorationen	PZZ. PER SCAT. PCS PER BOX PCS PER BOÎTE ST. PRO KARTON 24 pzz.			
	20x20 10x10	Formella Texture s/6 Inserito Texture s/6	190,00	12,00 12,00	12 6	Cotto/Grigio/Viola
	20x20 10x10 4,5x20	Formella Jardin s/4 Inserito Jardin s/4 Listello Jardin	190,00	12,00 10,00 8,00	4 4 8	Cotto/Grigio/Beige
	20x20 10x10 10x10 10x10	Formella Vintage Inserito Vintage Greca Vintage Trama Vintage		34,00 15,00 14,00 13,00	4 6 6 6	Beige/Cotto
	2,5x20	Listello Strutturato Vogue		9,00	24	Tutti i colori tranne: Noir - All colours except: Noir Toutes les couleurs sauf: Noir - Alle Farben ausser: Noir

Schemi di Posa . Laying Sketch. Schémas de Pose. Modulverlegungsbeispiele.

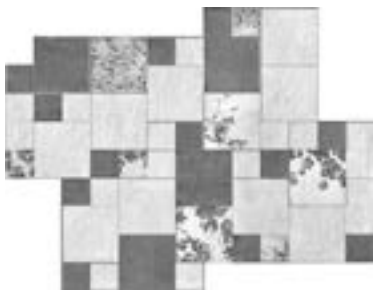

***MODULARE JARDIN BEIGE
(1 Mq Nominale)**
Ivoire 10x10 = 16 pzz
Noisette 10x10 = 12 pzz
Ivoire 20x20 = 9 pzz
Noisette 20x20 = 4 pzz
inserto Jardin s/4 10x10 = 4 pzz
inserto Jardin s/4 20x20 = 4 pzz



***MODULARE TEXTURE COTTO
(1 Mq Nominale)**
Ivoire 10x10 = 11 pzz
Rouge 10x10 = 7 pzz
Orange 10x10 = 8 pzz
Ivoire 20x20 = 6 pzz
Rouge 20x20 = 3 pzz
Orange 20x20 = 2 pzz
inserto Texture s/6 10x10 = 6 pzz
inserto Texture s/6 20x20 = 6 pzz

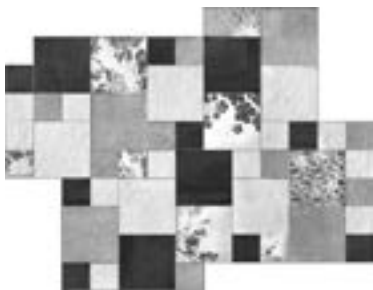

***MODULARE JARDIN COTTO
(1 Mq Nominale)**
Ivoire 10x10 = 11 pzz
Rouge 10x10 = 8 pzz
Orange 10x10 = 9 pzz
Ivoire 20x20 = 5 pzz
Rouge 20x20 = 4 pzz
Orange 20x20 = 4 pzz
inserto Jardin s/4 10x10 = 4 pzz
inserto Jardin s/4 20x20 = 4 pzz



***MODULARE TEXTURE GRIGIO
(1 Mq Nominale)**
Ivoire 10x10 = 11 pzz
Noir 10x10 = 7 pzz
Fumée 10x10 = 8 pzz
Ivoire 20x20 = 6 pzz
Noir 20x20 = 3 pzz
Fumée 20x20 = 2 pzz
inserto Texture s/6 10x10 = 6 pzz
inserto Texture s/6 20x20 = 6 pzz













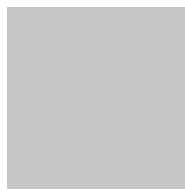

***MODULARE JARDIN GRIGIO
(1 Mq Nominale)**
Ivoire 10x10 = 11 pzz
Lilas 10x10 = 8 pzz
Fumée 10x10 = 9 pzz
Ivoire 20x20 = 5 pzz
Lilas 20x20 = 4 pzz
Fumée 20x20 = 4 pzz
inserto Jardin s/4 10x10 = 4 pzz
inserto Jardin s/4 20x20 = 4 pzz





***MODULARE TEXTURE VIOLA
(1 Mq Nominale)**
Ivoire 10x10 = 11 pzz
Violet 10x10 = 7 pzz
Lilas 10x10 = 8 pzz
Ivoire 20x20 = 6 pzz
Lilas 20x20 = 3 pzz
Violet 20x20 = 2 pzz
inserto Texture s/6 10x10 = 6 pzz
inserto Texture s/6 20x20 = 6 pzz

*Per il prezzo del modulare richiedere il preventivo in azienda. *For the price of the modular pattern please ask for a quotation to the company.
*Veuillez demander au service commercial le préventif du modulaire. *Für den Modulpreis bitte im Werk anfragen.
*Цену для модульной укладки можно узнать на фабрике.

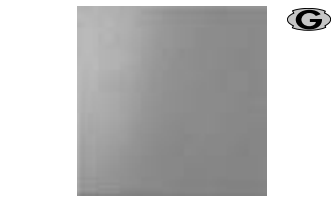

FORMA SHAPE FORME FORM	ARTICOLO ITEM ARTICLE ARTIKEL	1° SCELTA PREZZO SFUSO 1° CHOICE LOOSE PRICE 1 CHOIX PRIX EN Vrac 1 WAHL. PREIS LOSE € . pz	PZZ. PER SCAT. PCS PER BOX PCS PER BÖTE ST. PRO KARTON	FORMA SHAPE FORME FORM	ARTICOLO ITEM ARTICLE ARTIKEL	1° SCELTA PREZZO SFUSO 1° CHOICE LOOSE PRICE 1 CHOIX PRIX EN Vrac 1 WAHL. PREIS LOSE € . pz	PZZ. PER SCAT. PCS PER BOX PCS PER BÖTE ST. PRO KARTON
	PEZZI SPECIALI Special pieces - Pièces spéciales Spezielle Stücke				PEZZI SPECIALI Special pieces - Pièces spéciales Spezielle Stücke		
	Frontale gradino con Lamella 4,3x31,7	27,00	4		Torello 1	22,00	2
	Spigolo Frontale 4,3x4,3	10,00	1		Spigolo 3	24,00	1
	V-cap (Bordo Tavolo 1) 6x20	11,00	4		Angolo 6 (dx-sx)	24,00	2
	C-cap (Spigolo 3 esterno) 3x6	14,00	1		Battistraccio 2 linea	22,00	2
	Sguscia Esterna 2 3x20	10,00	4		Battistraccio 5 Angolo	24,00	1
	Unghia Esterna 5 3x3	11,00	1		Battistraccio 4 (sx)	24,00	1
	B.C. (Bullnose) 10x10	2,70	68		Battistraccio 4 (dx)	24,00	1
	D.B.C. (Corner) 10x10	3,70	68				
Disponibile nei colori: - Available in the colors: Disponibles dans les couleurs: In den Farben lieferbar: Fumée, Ivoire, Lilas, Noisette, Orange, Rouge, Violette				Disponibile nei colori: - Available in the colors: Disponibles dans les couleurs: In den Farben lieferbar: Fumée, Ivoire, Lilas, Noisette, Orange, Rouge			
	LAVELLI Basins - Éviers - Waschbecken				LAVELLI* Basins - Éviers - Waschbecken		
	Lavello Bagno da incasso ovale (56,5x46,5)	640,00			Lavello Spaccatella rotondo (d'appoggio)* (ø46,5 - h 15,5) (per gli abbinamenti, vedi articoli spaccatella mix) <i>Imballo speciale con addebito di € 15,00</i>	690,00	
	Catino da incasso rotondo (ø47)	620,00					
	Catino d'appoggio rotondo (ø39)	670,00 720,00	Monocolore Bicolore				
	Catino d'appoggio ovale (39,5x50)	720,00 770,00	Monocolore Bicolore		Lavello Spaccatella ovale (l 59,5 - p 46,5 - h 15,5) (per gli abbinamenti, vedi articoli spaccatella mix) <i>Imballo speciale con addebito di € 17,00</i>	880,00	
	Lavello Cucina da incasso quadro (40x40)	600,00					
	Gocciolatoio da incasso (40x40)	420,00					
Disponibili in tutti i colori - Available in all colours Disponibles dans toutes les couleurs - In allen Farben lieferbar				* Lavelli speciali realizzati a mano solo su ordinazione. Imballo speciale con addebito di € 15,00 per il lavello rotondo e € 17,00 per quello ovale. * Custom hande made bathroom sink available for special order only. Extra charge of € 15,00 for special packaging of the round sink and € 17,00 for the oval sink. * Eviers spéciaux réalisés à la main uniquement sur commande. Emballage spécial au coût de 15 € pour l'évier rond et 17 € pour l'évier ovale. * Nur auf Anfrage angefertigte Waschbecken. Sonderverpackung mit Extrakosten: je Eur 15,- fuer runde Waschbecken und Eur 17,- fuer ovale Waschbecken.			
Vedi note a pagina 52 - See notes on page 52 Voir notes à page 52 - Siehe Anmerkungen auf Seite 52							

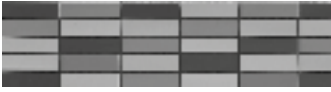
FORMA&FORMATO SHAPE & SIZE FORME ET FORMAT FORM UND FORMAT		ARTICOLO ITEM ARTICLE ARTIKEL	1° SCELTA PREZZO SFUSO 1° CHOICE LOOSE PRICE 1 CHOIX PRIX EN VRAC 1 WAHL PREIS LOSE € . mq	COMM. PREZZO SFUSO COMM. LOOSE PRICE COMM. PRIX EN VRAC HW PREIS LOSE € . mq	Pz x Box	Mq x Box	Kg x Box	Box x Pall.	Mq x Pall.	Kg x Pall.
 14x56 ± 9 mm BICOTTURA IN PASTA BIANCA WHITE BODY DOUBLE-FIRED TILES	FLAIR AVORIO	62,00	37,00	Imballaggio SFUSO LOOSE EN VRAC LOSE 14x56 10 0,79 13,50 70 55,30 961						
	FLAIR AZZURRO	62,00	37,00							
	FLAIR BIANCO	62,00	37,00							
	FLAIR ARANCIO	64,00	38,00							
	FLAIR BLU	64,00	38,00							
	FLAIR BORDEAUX	64,00	38,00							
	FLAIR GRIGIO	64,00	38,00							
	FLAIR LILLA FLAIR NERO	64,00 64,00	38,00 38,00							
 30x30 RETT ± 10 mm GRES FINE PORCELLANATO SMALTATO GLAZED FINE PORCELAIN STONEWARE	FLAIR AVORIO RETT	52,00	32,00	Imballaggio SFUSO LOOSE EN VRAC LOSE 30x30 11 0,99 20,50 44 43,56 918						
	FLAIR BIANCO RETT	52,00	32,00							
	FLAIR BLU RETT	52,00	32,00							
	FLAIR BORDEAUX RETT	52,00	32,00							
	FLAIR GRIGIO RETT	52,00	32,00							
	FLAIR LILLA RETT	52,00	32,00							
FORMA SHAPE FORME FORM	FORMATO SIZE FORMAT FORMAT	ARTICOLO ITEM ARTICLE ARTIKEL	1° SCELTA PREZZO SFUSO 1° CHOICE LOOSE PRICE 1 CHOIX PRIX EN VRAC 1 WAHL PREIS LOSE € . pz	PZZ. PER SCAT. PCS PER BOX PCS PER BOÎTE ST. PRO KARTON	VERSIONE DI COLORE VERSION OF COLOUR VERSION COULEUR FARBEAUSFÜHRUNG					
		DECORAZIONI Decorations - Décors - Dekorationen								
	14x56	Inserto Flair s/3	26,00	6	Avorio/Bianco					
	14x56 4x56	Inserto Crystal Listello Crystal	34,00 18,00	6 6						
	4x56	Listello Plane	23,00	6	Avorio/Bianco					
	2x56	Listello Vertical	22,00	6						
	2x56	Listello Pyramid	18,00	6	Argento/Bianco/Bordeaux/Lilla					
	2x2	Tozzetto Pyramid	4,00	24						
	1,5x56	Listello Mirror	30,00	6	Argento					
	1x100	Listello Iron	18,00	4						
		PEZZI SPECIALI Special pieces - Pièces spéciales Spezielle Stücke								
	5,5x56	Terminale V-Cap	26,00	4	Avorio/Bianco					
FORMA SHAPE FORME FORM	ARTICOLO ITEM ARTICLE ARTIKEL	1° SCELTA PREZZO SFUSO 1° CHOICE LOOSE PRICE 1 CHOIX PRIX EN VRAC 1 WAHL PREIS LOSE € . pz	FORMA SHAPE FORME FORM	ARTICOLO ITEM ARTICLE ARTIKEL	1° SCELTA PREZZO SFUSO 1° CHOICE LOOSE PRICE 1 CHOIX PRIX EN VRAC 1 WAHL PREIS LOSE € . pz					
	LAVELLI Basins - Éviers - Waschbecken			LAVELLI Basins - Éviers - Waschbecken						
	Catino d'appoggio rotondo (ø39) Monocolore Bicolore	670,00 720,00		Catino d'appoggio ovale (39,5x50) Monocolore Bicolore	720,00 770,00					
Disponibili in tutti i colori - Available in all colours - Disponibles dans toutes les couleurs - In allen Farben lieferbar										

FORMA&FORMATO SHAPE & SIZE FORME ET FORMAT FORM UND FORMAT	ARTICOLO ITEM ARTICLE ARTIKEL	1° SCELTA PREZZO SFUSO 1° CHOICE LOOSE PRICE 1 CHOIX PRIX EN VRAC 1 WAHL PREIS LOSE € . mq	COMM. PREZZO SFUSO COMM. LOOSE PRICE COMM. PRIX EN VRAC HW PREIS LOSE € . mq		Pz x Box	Mq x Box	Kg x Box	Box x Pall.	Mq x Pall.	Kg x Pall.										
 14x56 ± 9 mm BICOTTURA IN PASTA BIANCA WHITE BODY DOUBLE-FIRED TILES	CELESTE CENERE PESCA ROSA ANTICO VANIGLIA BLU BALTICO CIOCCOLATO FANGO ORCHIDEA	60,00 60,00 60,00 60,00 60,00 62,00 62,00 62,00 62,00	36,00 36,00 36,00 36,00 36,00 37,00 37,00 37,00 37,00		Imballaggio SFUSO LOOSE EN VRAC LOSE 14x56						10	0,79	13,50	70	55,30	961				
 30x30 RETT ± 10 mm GRES PORCELLANATO SMALTATO GLAZED PORCELAIN STONEWARE	BLU BALTICO RETT CIOCCOLATO RETT FANGO RETT PESCA RETT	52,00 52,00 52,00 52,00	32,00 32,00 32,00 32,00		Imballaggio SFUSO LOOSE EN VRAC LOSE 30x30						11	0,99	20,50	44	43,56	918				
	MOSAICI Mosaics - Mosaiques - Mosaiken		€ . pz																	
 PREINCISO TENTAZIONI* 14x56	BLU BALTICO CELESTE CENERE CIOCCOLATO FANGO ORCHIDEA PESCA ROSA ANTICO VANIGLIA		13,00 13,00 13,00 13,00 13,00 13,00 13,00 13,00 13,00		Pz x Box	Mq x Box	Kg x Box	Box x Pall.	Mq x Pall.	Kg x Pall.	Imballaggio pz				6	0,47	8,10	-	-	-
			€ . foglio sheet/feuille/Blatt		Pz x Box	Mq x Box	Kg x Box	Box x Pall.	Mq x Pall.	Kg x Pall.										
 MOSAICO TENTAZIONI MIX TESSERA 9x2,5 cm FOGLIO/SHEET/FEUILLE/BLATT 14x56	MIX VIOLA Composto da: Cenere, Fango, Orchidea MIX COLOR Composto da: Blu Baltico, Celeste, Cenere, Cioccolato, Fango, Orchidea, Pesca, Rosa Antico, Vaniglia		18,00 19,00		6	0,47	8,10	-	-	-										

*PREINCISO VENDUTO A SCATOLE COMPLETE - PRESCORED TILES SOLD BY THE FULL BOX - PRÉCOUPÉ VENDU À BOITE ENTIÈRE - VORGEPRÆGTE FLIESEN WERDEN NUR IN VOLLEN KARTONS VERKAUFT

FORMA SHAPE FORME FORM	FORMATO SIZE FORMAT FORMAT	ARTICOLO ITEM ARTICLE ARTIKEL	1° SCELTA PREZZO SFUSO 1° CHOICE LOOSE PRICE 1. CHOIX PRIX EN VRAC 1 WAHL PREIS LOSE € . pz	PZZ. PER SCAT. PCS PER BOX PCS PER BOÎTE ST. PRO KARTON	VERSIONE DI COLORE VERSION OF COLOUR VERSION COULEUR FARBEAUSFÜHRUNG
		DECORAZIONI Decorations - Décors - Dekorationen			
	14x56 14x56	Inserto Élite Trama Élite	30,00 23,00	6 6	Celeste/Cenere/Rosa Antico/Vaniglia
	14x56	Inserto Modern s/2	28,00	6	Cenere
	14x56	Inserto Flowers s/2	30,00	6	Celeste/Rosa Antico/Vaniglia
	2,5x56	Listello Modern	13,00	6	Blu Baltico/Cioccolato/Fango/Pesca Orchidea
	2x56	Listello Tentazioni	12,00	6	Blu Baltico/Cioccolato/Fango/Pesca Orchidea
	1,5x56	Listello Mirror	30,00	6	Argento
		PEZZI SPECIALI Special pieces - Pièces spéciales Spezielle Stücke			
	1,5x28 1,5x1,5	Raccordo Jolly Spigolo Jolly	13,00 16,00	4 4	Tutti i colori - All colours
	5,5x56	Terminale V-Cap	26,00	4	Celeste/Cenere/Rosa Antico/Vaniglia
FORMA SHAPE FORME FORM	ARTICOLO ITEM ARTICLE ARTIKEL	1° SCELTA PREZZO SFUSO 1° CHOICE LOOSE PRICE 1. CHOIX PRIX EN VRAC 1 WAHL PREIS LOSE € . pz	FORMA SHAPE FORME FORM	ARTICOLO ITEM ARTICLE ARTIKEL	1° SCELTA PREZZO SFUSO 1° CHOICE LOOSE PRICE 1. CHOIX PRIX EN VRAC 1 WAHL PREIS LOSE € . pz
	LAVELLI Basins - Éviers - Waschbecken			LAVELLI Basins - Éviers - Waschbecken	
	Catino d'appoggio rotondo (ø39) Monocolore Bicolore	670,00 720,00		Catino d'appoggio ovale (39,5x50) Monocolore Bicolore	720,00 770,00
Disponibili in tutti i colori - Available in all colours - Disponibles dans toutes les couleurs - In allen Farben lieferbar					
Vedi note a pagina 52 - See notes on page 52 - Voir notes à page 52 - Siehe Anmerkungen auf Seite 52					

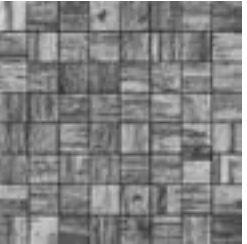
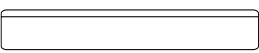
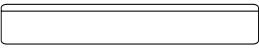
FORMA&FORMATO SHAPE & SIZE FORME ET FORMAT FORM UND FORMAT	ARTICOLO ITEM ARTICLE ARTIKEL	1° SCELTA PREZZO SFUSO 1° CHOICE LOOSE PRICE 1 CHOIX PRIX EN VRAC 1 WAHL PREIS LOSE € . mq	COMM. PREZZO SFUSO COMM. LOOSE PRICE COMM. PRIX EN VRAC HW PREIS LOSE € . mq		Pz x Box	Mq x Box	Kg x Box	Box x Pall.	Mq x Pall.	Kg x Pall.
 47,5x47,5 RETT # 11 mm	ALAIN RETT BRIGITTE RETT CAROL RETT CATHERINE RETT SOPHIA RETT JEAN PAUL RETT	50,00 50,00 50,00 50,00 50,00 50,00	30,00 30,00 30,00 30,00 30,00 30,00		Imballaggio SFUSO LOOSE EN VRAC LOSE 47,5x47,5 5 1,128 25,50 28 31,584 730					
 48x48 R11 # 11 mm	ALAIN R11 BRIGITTE R11 CAROL R11 CATHERINE R11 SOPHIA R11 JEAN PAUL R11	42,00 42,00 42,00 42,00 42,00 42,00	27,00 27,00 27,00 27,00 27,00 27,00		Imballaggio SFUSO LOOSE EN VRAC LOSE 48x48 5 1,152 26,50 28 32,256 758					
 QUADROTTA SAINT TROPEZ 23,6x23,6 RETT	QUADROTTA ALAIN QUADROTTA BRIGITTE QUADROTTA CAROL QUADROTTA CATHERINE QUADROTTA SOPHIA QUADROTTA JEAN PAUL	72,00 72,00 72,00 72,00 72,00 72,00			Pz x Box 20	Mq x Box 1,11	Kg x Box 23,00	Box x Pall. 30	Mq x Pall. 33,3	Kg x Pall. 706
	MOSAICI Mosaics - Mosaiques - Mosaiken	€ . foglio sheet/feuille/Blatt								
 MOSAICO SAINT TROPEZ TESSERA 5,7x5,7 RETT FOGLIO/SHEET/FEUILLE/BLATT 47,5x47,5	ALAIN BRIGITTE CAROL CATHERINE SOPHIA JEAN PAUL	28,00 28,00 28,00 28,00 28,00 28,00			Pz x Box 3	Mq x Box 0,678	Kg x Box 13,50	Box x Pall. 20	Mq x Pall. 13,56	Kg x Pall. 286
 BATTISCOPA 8x47,5 RETT  BATTISCOPA 8x48 R11* *Solo su ordinazione Upon request only	ALAIN BRIGITTE CAROL CATHERINE SOPHIA JEAN PAUL	14,00 14,00 14,00 14,00 14,00 14,00 € . ml			Pz x Box 15	Ml x Box 7,125	Kg x Box 12,00	Box x Pall. 54	Ml x Pall. 384,75	Kg x Pall. 664

FORMA SHAPE FORME FORM	FORMATO SIZE FORMAT FORMAT	ARTICOLO ITEM ARTICLE ARTIKEL	1° SCELTA PREZZO SFUSO 1° CHOICE LOOSE PRICE 1 CHOIX PRIX EN VRAC 1 WAHL PREIS LOSE € . pz	PZZ. PER SCAT. PCS PER BOX PCS PER BOÎTE ST. PRO KARTON	VERSIONE DI COLORE VERSION OF COLOUR VERSION COULEUR FARBEAUSFÜHRUNG
		DECORAZIONI Decorations - Décors - Dekorationen			
	11x47,5 rett	Fascia Magazine (mix 8 pezzi)	10,00	8	Alain/Brigitte/Catherine/Sophia
	9,3x47,5 rett	Listello Fango	3,50	10	Unica Sole Version - Unique - Einzige Ausführung
	9,3x47,5 rett	Listello Polvere	3,50	10	Unica Sole Version - Unique - Einzige Ausführung
	9,3x9,3 rett	Tozzetto Saint Tropez	1,40	10	Tutti i colori - All colours

FORMA SHAPE FORME FORM	ARTICOLO ITEM ARTICLE ARTIKEL	1° SCELTA PREZZO SFUSO 1° CHOICE LOOSE PRICE 1 CHOIX PRIX EN VRAC 1 WAHL PREIS LOSE € . pz	PZZ. PER SCAT. PCS PER BOX PCS PER BOÎTE ST. PRO KARTON	FORMA SHAPE FORME FORM	ARTICOLO ITEM ARTICLE ARTIKEL	1° SCELTA PREZZO SFUSO 1° CHOICE LOOSE PRICE 1 CHOIX PRIX EN VRAC 1 WAHL PREIS LOSE € . pz	PZZ. PER SCAT. PCS PER BOX PCS PER BOÎTE ST. PRO KARTON
	PEZZI SPECIALI - Special pieces - Pièces spéciales Spezielle Stücke						
	Elemento ad "L" R11 15x48x5	25,00			Elemento ad "L" RETT 15x47,5x5	25,00	
Disponibili in tutti i colori - Available in all colours Disponibles dans toutes les couleurs - In allen Farben lieferbar				Solo su ordinazione - Upon request only			

CASSETTONE SAINT TROPEZ

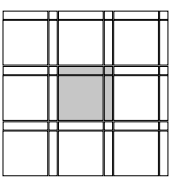

cassettone composto da:
47,5x47,5 rett = 69,9%
9,3x47,5 rett = 27,4%
9,3x9,3 rett = 2,7%

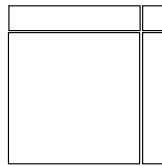

CASSETTONE SAINT TROPEZ

- ALAIN 47,5x47,5 rett, tozzetto 9,3x9,3 rett - Listello fango 9,3x47,5 rett
- BRIGITTE 47,5x47,5 rett, tozzetto 9,3x9,3 rett - Listello fango 9,3x47,5 rett
- CATHERINE 47,5x47,5 rett, tozzetto 9,3x9,3 rett - Listello fango 9,3x47,5 rett
- SOPHIA 47,5x47,5 rett, tozzetto 9,3x9,3 rett - Listello fango 9,3x47,5 rett
- CAROL 47,5x47,5 rett, tozzetto 9,3x9,3 rett - Listello polvere 9,3x47,5 rett
- JEAN PAUL 47,5x47,5 rett, tozzetto 9,3x9,3 rett - Listello polvere 9,3x47,5 rett

19 mm - "13/16"
spessore
thickness







NOVITÀ

FORMA&FORMATO SHAPE & SIZE FORME ET FORMAT FORM UND FORMAT	ARTICOLO ITEM ARTICLE ARTIKEL	1° SCELTA PREZZO SFUSO 1° CHOICE LOOSE PRICE 1 CHOIX PRIX EN VRAC 1 WAHL PREIS LOSE € . mq	COMM. PREZZO SFUSO COMM. LOOSE PRICE COMM. PRIX EN VRAC H/W PREIS LOSE € . mq	Pz x Box	Mq x Box	Kg x Box	Box x Pall.	Mq x Pall.	Kg x Pall.
 60x60 R11 RETT # 19 mm	ALAIN R11 rett	95,00	53,00	Imballaggio SFUSO LOOSE EN VRAC LOSE 60x60					
	BRIGITTE R11 rett	95,00	53,00	2	0,72	30,80	32	23,04	1.002
	CAROL R11 rett	95,00	53,00						

FORMA SHAPE FORME FORM	ARTICOLO ITEM ARTICLE ARTIKEL	1° SCELTA PREZZO SFUSO 1° CHOICE LOOSE PRICE 1 CHOIX PRIX EN VRAC 1 WAHL PREIS LOSE € . pz	PZZ. PER SCAT. PCS PER BOX PCS PER BOÎTE ST. PRO KARTON	FORMA SHAPE FORME FORM	ARTICOLO ITEM ARTICLE ARTIKEL	1° SCELTA PREZZO SFUSO 1° CHOICE LOOSE PRICE 1 CHOIX PRIX EN VRAC 1 WAHL PREIS LOSE € . pz	PZZ. PER SCAT. PCS PER BOX PCS PER BOÎTE ST. PRO KARTON
	PEZZI SPECIALI - Special pieces - Pièces spéciales Spezielle Stücke						
	Step molato R11 rettificato 30x60	46,00	3		Elemento ad "L" R11 rettificato 15x60x5	78,00	4
Disponibili in tutti i colori - Available in all colours - Disponibles dans toutes les couleurs - In allen Farben lieferbar							

FORMA&FORMATO SHAPE & SIZE FORME ET FORMAT FORM UND FORMAT		ARTICOLO ITEM ARTICLE ARTIKEL	1° SCELTA PREZZO SFUSO 1° CHOICE LOOSE PRICE 1 CHOIX PRIX EN VRAC 1 WAHL PREIS LOSE € . mq	COMM. PREZZO SFUSO COMM. LOOSE PRICE COMM. PRIX EN VRAC HW PREIS LOSE € . mq	Pz x Box	Mq x Box	Kg x Box	Box x Pall.	Mq x Pall.	Kg x Pall.
 15x90 ± 10 mm		BARBANERA (nero)	54,00	33,00	Imballaggio SFUSO LOOSE EN VRAC LOSE					
		BRIGANTINO (bianco)	54,00	33,00	15x90					
		BUCANIERE (marrone)	54,00	33,00	9	1,215	26,50	48	58,32	1.288
		CORSARO (castagno)	54,00	33,00						
		PIRATA (beige)	54,00	33,00						
 15x60,8 ± 10 mm		BARBANERA (nero)	46,00	30,00	Imballaggio SFUSO LOOSE EN VRAC LOSE					
		BRIGANTINO (bianco)	46,00	30,00	15x60,8					
		BUCANIERE (marrone)	46,00	30,00	14	1,28	27,00	40	51,20	1.096
		CORSARO (castagno)	46,00	30,00						
		PIRATA (beige)	46,00	30,00						
 10x50 ± 10 mm		BARBANERA (nero)	46,00	30,00	Imballaggio SFUSO LOOSE EN VRAC LOSE					
		BRIGANTINO (bianco)	46,00	30,00	10x50					
		BUCANIERE (marrone)	46,00	30,00	10	0,50	10,25	90	45,00	939
		CORSARO (castagno)	46,00	30,00						
		PIRATA (beige)	46,00	30,00						
 BATTISCOPIA 7,5x60,8		BARBANERA (nero)	14,00	9,00	Imballaggio SFUSO LOOSE EN VRAC LOSE					
		BRIGANTINO (bianco)	14,00	9,00	BATTISCOPIA 7,5x60,8					
		BUCANIERE (marrone)	14,00	9,00	Pz x Box	Ml x Box	Kg x Box	Box x Pall.	Ml x Pall.	Kg x Pall.
		CORSARO (castagno)	14,00	9,00	20	12,16	18,00	50	608	916
		PIRATA (beige)	14,00	9,00						
FORMA SHAPE FORME FORM	FORMATO SIZE FORMAT FORMAT	ARTICOLO ITEM ARTICLE ARTIKEL	1° SCELTA PREZZO SFUSO 1° CHOICE LOOSE PRICE 1 CHOIX PRIX EN VRAC 1 WAHL PREIS LOSE € . pz	PZZ. PER SCAT. PCS PER BOX PCS PER BOÎTE ST. PRO KARTON	VERSIONE DI COLORE VERSION OF COLOUR VERSION COULEUR FARBEAUSFÜHRUNG					
		DECORAZIONI Decorations - Décors - Dekorationen								
	1x100	Listello Iron	18,00	4	Unica - Sole version - Unique - Einzige Ausführung					
FORMA SHAPE FORME FORM	ARTICOLO ITEM ARTICLE ARTIKEL	1° SCELTA PREZZO SFUSO 1° CHOICE LOOSE PRICE 1 CHOIX PRIX EN VRAC 1 WAHL PREIS LOSE € . pz	PZZ. PER SCAT. PCS PER BOX PCS PER BOÎTE ST. PRO KARTON	FORMA SHAPE FORME FORM	ARTICOLO ITEM ARTICLE ARTIKEL	1° SCELTA PREZZO SFUSO 1° CHOICE LOOSE PRICE 1 CHOIX PRIX EN VRAC 1 WAHL PREIS LOSE € . pz	PZZ. PER SCAT. PCS PER BOX PCS PER BOÎTE ST. PRO KARTON			
	PEZZI SPECIALI Special pieces - Pièces spéciales Spezielle Stücke				PEZZI SPECIALI Special pieces - Pièces spéciales Spezielle Stücke					
	Frontale gradino con Lamella 4,3x25	27,00	4	○	Spigolo Frontale 4,3x4,3	10,00	1			

Disponibili in tutti i colori - Available in all colours - Disponibles dans toutes les couleurs - In allen Farben lieferbar

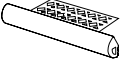
FORMA&FORMATO SHAPE & SIZE FORME ET FORMAT FORM UND FORMAT		ARTICOLO ITEM ARTICLE ARTIKEL	1° SCELTA PREZZO SFUSO 1° CHOICE LOOSE PRICE 1 CHOIX PRIX EN VRAC 1 WAHL PREIS LOSE	COMM. PREZZO SFUSO COMM. LOOSE PRICE COMM. PRIX EN VRAC HW PREIS LOSE	Pz x Box	Mq x Box	Kg x Box	Box x Pall.	Mq x Pall.	Kg x Pall.
 8,6x35 ± 10 mm		CILIEGIO	46,00	30,00	Imballaggio SFUSO LOOSE EN VRAC LOSE					
		IROKO	46,00	30,00	8,6x35					
		MORADO	46,00	30,00	20	0,602	12,50	84	50,57	1.066
		TEAK	46,00	30,00						
		WENGÈ	46,00	30,00						
 BATTISCOPA 8,6x35		CILIEGIO	14,00	9,00	Pz x Box	Ml x Box	Kg x Box	Box x Pall.	Ml x Pall.	Kg x Pall.
		IROKO	14,00	9,00	Imballaggio SFUSO LOOSE EN VRAC LOSE					
		MORADO	14,00	9,00	BATTISCOPA 8,6x35					
		TEAK	14,00	9,00	30	10,5	18,00	36	378	664
		WENGÈ	14,00	9,00						
FORMA SHAPE FORME FORM	FORMATO SIZE FORMAT FORMAT	ARTICOLO ITEM ARTICLE ARTIKEL	1° SCELTA PREZZO SFUSO 1° CHOICE LOOSE PRICE 1 CHOIX PRIX EN VRAC 1 WAHL PREIS LOSE	PZZ. PER SCAT. PCS PER BOX PCS PER BOÎTE ST. PRO KARTON	VERSIONE DI COLORE VERSION OF COLOUR VERSION COULEUR FARBEAUSFÜHRUNG					
		DECORAZIONI Decorations - Décors - Dekorationen	€ . pz							
  	8,6x8,6	Tozzetto Taiga	6,00	5	Ciliegio-Iroko / Morado-Iroko Morado-Teak / Teak-Wengè					
	17,2x17,2	Inserto Taiga	8,00	4	Iroko*-Ciliegio / Morado*-Iroko Morado*-Teak / Teak*-Wengè					
	6x35 6x6	Fascia Taiga Angolo Fascia Taiga	13,00 13,00	8 5	Unica - Sole version Unique - Einzige Ausführung					
FORMA SHAPE FORME FORM	ARTICOLO ITEM ARTICLE ARTIKEL	1° SCELTA PREZZO SFUSO 1° CHOICE LOOSE PRICE 1 CHOIX PRIX EN VRAC 1 WAHL PREIS LOSE	PZZ. PER SCAT. PCS PER BOX PCS PER BOÎTE ST. PRO KARTON	FORMA SHAPE FORME FORM	ARTICOLO ITEM ARTICLE ARTIKEL	1° SCELTA PREZZO SFUSO 1° CHOICE LOOSE PRICE 1 CHOIX PRIX EN VRAC 1 WAHL PREIS LOSE	PZZ. PER SCAT. PCS PER BOX PCS PER BOÎTE ST. PRO KARTON			
	PEZZI SPECIALI Special pieces - Pièces spéciales Spezielle Stücke	€ . pz			PEZZI SPECIALI Special pieces - Pièces spéciales Spezielle Stücke	€ . pz				
	Frontale gradino con Lamella 4,3x25	27,00	4	○	Spigolo Frontale 4,3x4,3	10,00	1			

Disponibili in tutti i colori - Available in all colours - Disponibles dans toutes les couleurs - In allen Farben lieferbar

*COLORE CORNICE ESTERNA - EXTERNAL FRAME COLOR - COULEUR DU CADRE EXTÉRIEUR - FARBE AUSSENRAHMEN

SCHEMI DI POSA. INSTALLATION LAYING. SCHÉMAS DE POSE. VERLEGUNGSVORSCHLÄGE.

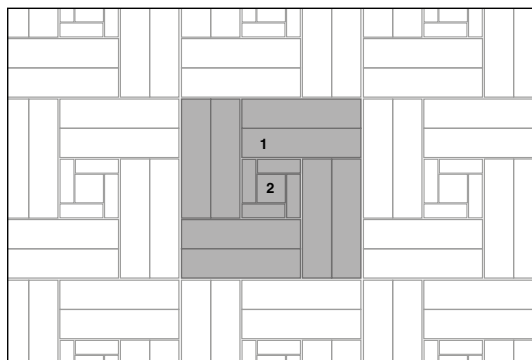

MODULO 1

- 1 8,6x35 = 89%
- 2 Inserto 17,2x17,2 = 11%
(= 3,7 pzz. al mq)

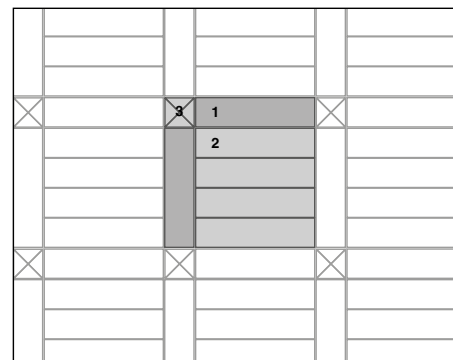

















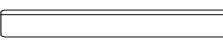

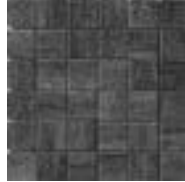
MODULO 2

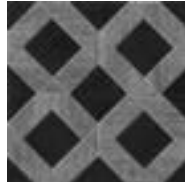
- 1 8,6x35 = 32%
- 2 8,6x35 = 64%
- 3 Tozzetto 8,6x8,6 = 4%
(= 5,32 pzz. al mq)

FORMA&FORMATO SHAPE & SIZE FORME ET FORMAT FORM UND FORMAT		ARTICOLO ITEM ARTICLE ARTIKEL	1° SCELTA PREZZO SFUSO 1° CHOICE LOOSE PRICE 1 CHOIX PRIX EN VRAC 1 WAHL PREIS LOSE	COMM. PREZZO SFUSO COMM. LOOSE PRICE COMM. PRIX EN VRAC HW PREIS LOSE	Pz x Box	Mq x Box	Kg x Box	Box x Pall.	Mq x Pall.	Kg x Pall.
<p>10x50 ± 10 mm</p>		ASPEN grigio pietra	46,00	30,00	Imballaggio SFUSO LOOSE EN VRAC LOSE					
		BERGEN muschio	46,00	30,00	10x50					
		CALGARY beige	46,00	30,00	10	0,50	10,25	90	45,00	935
		CORTINA ruggine	46,00	30,00	19	0,95	19,00	48	45,60	928
<p>15x60,8 ± 10 mm</p>		ASPEN grigio pietra	46,00	30,00	Imballaggio SFUSO LOOSE EN VRAC LOSE					
		BERGEN muschio	46,00	30,00	15x60,8					
		CALGARY beige	46,00	30,00	14	1,28	26,00	40	51,20	1.056
		CORTINA ruggine	46,00	30,00						
<p>BATTISCOPA 7,5x60,8</p>		ASPEN grigio pietra	14,00	9,00	Imballaggio SFUSO LOOSE EN VRAC LOSE					
		BERGEN muschio	14,00	9,00	BATTISCOPA 7,5x60,8					
		CALGARY beige	14,00	9,00	Pz x Box	Ml x Box	Kg x Box	Box x Pall.	Ml x Pall.	Kg x Pall.
		CORTINA ruggine	14,00	9,00	20	12,16	18,00	50	608	916
MOSAICI Mosaics - Mosaiques - Mosaiken			€ . foglio sheet/feuille/Blatt		Pz x Box	Mq x Box	Kg x Box	Box x Pall.	Mq x Pall.	Kg x Pall.
<p>MOSAICO COTTAGE TESSERA 5x5 FOGLIO/SHEET/FEUILLE/BLATT 30,2x30,2</p>		COTTAGE ASPEN	16,00		5	0,46	10,00	60	27,60	616
		COTTAGE BERGEN	16,00							
		COTTAGE CALGARY	16,00							
		COTTAGE CORTINA	16,00							
FORMA SHAPE FORME FORM	FORMATO SIZE FORMAT FORMAT	ARTICOLO ITEM ARTICLE ARTIKEL	1° SCELTA PREZZO SFUSO 1° CHOICE LOOSE PRICE 1 CHOIX PRIX EN VRAC 1 WAHL PREIS LOSE	PZZ. PER SCAT. PCS PER BOX PCS PER BOÎTE ST. PRO KARTON	VERSIONE DI COLORE VERSION OF COLOUR VERSION COULEUR FARBEAUSFÜHRUNG					
		DECORAZIONI Decorations - Décors - Dekorationen								
	10x50	Inserto Cargo s/6	28,00	6	Aspen/Bergen/Calgary/Cortina					
	1,2x50	Bacchetta Techno	15,00	12	Unica - Sole version - Unique - Einzige Ausführung					
	1x100	Listello Iron	18,00	4	Unica - Sole version - Unique - Einzige Ausführung					
FORMA SHAPE FORME FORM	ARTICOLO ITEM ARTICLE ARTIKEL	1° SCELTA PREZZO SFUSO 1° CHOICE LOOSE PRICE 1 CHOIX PRIX EN VRAC 1 WAHL PREIS LOSE	PZZ. PER SCAT. PCS PER BOX PCS PER BOÎTE ST. PRO KARTON	FORMA SHAPE FORME FORM	ARTICOLO ITEM ARTICLE ARTIKEL	1° SCELTA PREZZO SFUSO 1° CHOICE LOOSE PRICE 1 CHOIX PRIX EN VRAC 1 WAHL PREIS LOSE	PZZ. PER SCAT. PCS PER BOX PCS PER BOÎTE ST. PRO KARTON			
		PEZZI SPECIALI Special pieces - Pièces spéciales Spezielle Stücke			PEZZI SPECIALI Special pieces - Pièces spéciales Spezielle Stücke					
	Gradino Techno 30x60 (2 pzz. 15x60)	78,00	2		Angolare Techno dx- sx 30x60 (2 pzz. 15x60)	170,00	1			

Disponibili in tutti i colori - Available in all colours - Disponibles dans toutes les couleurs - In allen Farben lieferbar

FORMA&FORMATO SHAPE & SIZE FORME ET FORMAT FORM UND FORMAT	ARTICOLO ITEM ARTICLE ARTIKEL	1° SCELTA PREZZO SFUSO 1° CHOICE LOOSE PRICE 1 CHOIX PRIX EN VRAC 1 WAHL PREIS LOSE € . mq	COMM. PREZZO SFUSO COMM. LOOSE PRICE COMM. PRIX EN VRAC HW PREIS LOSE € . mq		Pz x Box	Mq x Box	Kg x Box	Box x Pall.	Mq x Pall.	Kg x Pall.
 15x60,8 ± 10 mm  	BARRIQUE BIANCO	46,00	30,00	Imballaggio SFUSO LOOSE EN VRAC LOSE 15x60,8	14	1,28	26,00	40	51,20	1.056
	BARRIQUE CASTAGNO	46,00	30,00							
	BARRIQUE MOGANO	46,00	30,00							
	BARRIQUE NERO	46,00	30,00							
	BARRIQUE OCRA	46,00	30,00							
 10x50 ± 10 mm  	BARRIQUE BIANCO	46,00	30,00	Imballaggio SFUSO LOOSE EN VRAC LOSE 10x50	10	0,50	10,25	90	45,00	939
	BARRIQUE CASTAGNO	46,00	30,00							
	BARRIQUE MOGANO	46,00	30,00							
	BARRIQUE NERO	46,00	30,00							
	BARRIQUE OCRA	46,00	30,00							
 10x50 ± 10 mm  	BARRIQUE AVORIO LUCIDO	52,00	31,00	Imballaggio SFUSO LOOSE EN VRAC LOSE 10x50	10	0,50	10,25	90	45,00	939
	BARRIQUE DIAMANTE LUCIDO	52,00	31,00							
 BATTISCOPA 7,5x60,8 	BARRIQUE BIANCO	14,00	9,00	Imballaggio SFUSO LOOSE EN VRAC LOSE BATTISCOPA 7,5x60,8	Pz x Box	Ml x Box	Kg x Box	Box x Pall.	Ml x Pall.	Kg x Pall.
	BARRIQUE CASTAGNO	14,00	9,00							
	BARRIQUE MOGANO	14,00	9,00							
	BARRIQUE NERO	14,00	9,00							
	BARRIQUE OCRA	14,00	9,00							
	MOSAICI Mosaics - Mosaïques - Mosaiken	€ . foglio sheet/feuille/Blatt			Pz x Box	Mq x Box	Kg x Box	Box x Pall.	Mq x Pall.	Kg x Pall.
 MOSAICO BARRIQUE TESSERA 5x5 FOGLIO/SHEET/FEUILLE/BLATT 30,4x30,4  	BARRIQUE BIANCO	16,00		5	0,46	10,00	60	27,60	616	
	BARRIQUE CASTAGNO	16,00								
	BARRIQUE MOGANO	16,00								
	BARRIQUE NERO	16,00								
	BARRIQUE OCRA	16,00								
 INTARSIO BARRIQUE 30,4x30,4  	INTARSIO MOGANO-OCRA	82,00		Pz x Box	Mq x Box	Kg x Box	Box x Pall.	Mq x Pall.	Kg x Pall.	
	INTARSIO OCRA-BIANCO	82,00								
				5	0,46	10,00	60	27,60	616	
 CASSETTONE COMPLETO 60,8x60,8  	CASSETTONE COMPLETO (1 mq = 2,7 pzz. cassettone completo) Composto da:									
	1 pzz. Intarsio	82,00								
	4 pzz. cornice/losanghe (colore cornice a scelta tra i colori del 15x60,8)	40,00								
		122,00								

FORMA SHAPE FORME FORM	FORMATO SIZE FORMAT FORMAT	ARTICOLO ITEM ARTICLE ARTIKEL	1° SCELTA PREZZO SFUSO 1° CHOICE LOOSE PRICE 1 CHOIX PRIX EN VRAC 1 WAHL PREIS LOSE € . pz	PZZ. PER SCAT. PCS PER BOX PCS PER BOÎTE ST. PRO KARTON	VERSIONE DI COLORE VERSION OF COLOUR VERSION COULEUR FARBEAUSFÜHRUNG		
		DECORAZIONI Decorations - Décors - Dekorationen					
	2,5x50	Sigaro Barrique	24,00	12	Castagno/Mogano/Nero		
	1x100	Listello Iron	18,00	4	Unica - Sole version - Unique - Einzige Ausführung		
FORMA SHAPE FORME FORM	ARTICOLO ITEM ARTICLE ARTIKEL	1° SCELTA PREZZO SFUSO 1° CHOICE LOOSE PRICE 1 CHOIX PRIX EN VRAC 1 WAHL PREIS LOSE € . pz	PZZ. PER SCAT. PCS PER BOX PCS PER BOÎTE ST. PRO KARTON	FORMA SHAPE FORME FORM	ARTICOLO ITEM ARTICLE ARTIKEL	1° SCELTA PREZZO SFUSO 1° CHOICE LOOSE PRICE 1 CHOIX PRIX EN VRAC 1 WAHL PREIS LOSE € . pz	PZZ. PER SCAT. PCS PER BOX PCS PER BOÎTE ST. PRO KARTON
	PEZZI SPECIALI Special pieces - Pièces spéciales Spezielle Stücke				PEZZI SPECIALI Special pieces - Pièces spéciales Spezielle Stücke		
	Frontale gradino con Lamella 4,3x25	27,00	4		Spigolo Frontale 4,3x4,3	10,00	1
Disponibili in tutti i colori - Available in all colours - Disponibles dans toutes les couleurs - In allen Farben lieferbar							

I Pavimenti della Costa Smeralda *7 pavimenti della Costa Smeralda*





FORMA&FORMATO SHAPE & SIZE FORME ET FORMAT FORM UND FORMAT	ARTICOLO ITEM ARTICLE ARTIKEL	1° SCELTA PREZZO SFUSO 1° CHOICE LOOSE PRICE 1 CHOIX PRIX EN VRAC 1 WAHL PREIS LOSE € . mq	COMM. PREZZO SFUSO COMM. LOOSE PRICE COMM. PRIX EN VRAC HW PREIS LOSE € . mq	Pz x Box	Mq x Box	Kg x Box	Box x Pall.	Mq x Pall.	Kg x Pall.
 25x25 ± 14 mm	 SUPERFICIE PASTELLO PEDRA BIANCA (sabbia) PEVERO (turchese) SUPERFICIE BRILLANTE LA MADDALENA (blu) SPARGI (turchese) TAVOLARA (lavanda) CAPRERA (verde) L'ASINARA (lilla)	70,00	42,00	Imballaggio SFUSO LOOSE EN VRAC LOSE 10x10 13 0,81 28,00 54 43,74 1.528					
		70,00	42,00						
		70,00	42,00						
		70,00	42,00						
		70,00	42,00						
		70,00	42,00						
 BATTISCOPA 8x25 ± 14 mm	 SUPERFICIE PASTELLO PEDRA BIANCA (sabbia) PEVERO (turchese) € . ml SUPERFICIE BRILLANTE LA MADDALENA (blu) SPARGI (turchese) TAVOLARA (lavanda) € . ml CAPRERA (verde) L'ASINARA (lilla)	17,00		Pz x Box 12	Ml x Box 3,00	Kg x Box 7,00	Box x Pall. 48	Ml x Pall. 144	Kg x Pall. 351
		17,00							
		17,00							
		17,00							
		17,00							
		17,00							

FORMA&FORMATO SHAPE & SIZE FORME ET FORMAT FORM UND FORMAT		ARTICOLO ITEM ARTICLE ARTIKEL	1° SCELTA PREZZO SFUSO 1° CHOICE LOOSE PRICE 1 CHOIX PRIX EN VRAC 1 WAHL PREIS LOSE	COMM. PREZZO SFUSO COMM. LOOSE PRICE COMM. PRIX EN VRAC HW PREIS LOSE	Pz x Box	Mq x Box	Kg x Box	Box x Pall.	Mq x Pall.	Kg x Pall.
<p>10x10 ± 13 mm</p>		IN ACQUA	53,00	32,00	Imballaggio SFUSO LOOSE EN VRAC LOSE 10x10					
		IN AVORIO	53,00	32,00	52	0,52	13,60	72	37,44	995
		IN BANANA	53,00	32,00						
		IN BIANCO	53,00	32,00						
		IN CREMA	53,00	32,00						
		IN LAVANDA	53,00	32,00						
		IN MELONE	53,00	32,00						
		IN SALATA	53,00	32,00						
		IN TURCHESE	53,00	32,00						
		IN BLU	55,00	33,00						
IN MENTA	55,00	33,00								
		MOSAICI Mosaics - Mosaiques - Mosaiken	€ . foglio sheet/feuille/Blatt		Pz x Box	Mq x Box	Kg x Box	Box x Pall.	Mq x Pall.	Kg x Pall.
<p>MOSAICO MIX IN TINTA TESSERA 2,2x2,2 FOGLIO/SHEET/FEUILLE/BLATT 30x30</p>		MIX BLU Composto da: In Bianco - In Turchese In Lavanda - In Blu	24,00		4	0,36	9,00	60	21,60	556
		MIX VERDE Composto da: In Bianco - In Salata In Acqua - In Menta	24,00							
FORMA SHAPE FORME FORM	FORMATO SIZE FORMAT FORMAT	ARTICOLO ITEM ARTICLE ARTIKEL	1° SCELTA PREZZO SFUSO 1° CHOICE LOOSE PRICE 1 CHOIX PRIX EN VRAC 1 WAHL PREIS LOSE	PZZ. PER SCAT. PCS PER BOX PCS PER BOÎTE ST. PRO KARTON	VERSIONE DI COLORE VERSION OF COLOUR VERSION COULEUR FARBEAUSFÜHRUNG					
		DECORAZIONI Decorations - Décors - Dekorationen	€ . pz							
	10x10	Insero In Estate Testa s/1	16,00	6	Unica (su avorio) - Sole version (on ivory) - Unique (sur ivoir) - Einzige Ausführung (auf Farbe in avorio)					
	10x10	Insero In Estate Gambi s/2	16,00	6						
	3,5x20	Listello In Estate	14,00	12	Acqua					
	10x20	Formella In Giardino	22,00	6						
	20x20	Formella In Giardino	42,00	3						
	5x20	Listello righe In Giardino	14,00	8						
5x5	Tozzetto In Giardino	8,00	12	Acqua/Avorio/Banana/Bianco/Blu/Crema Lavanda/Melone/Menta/In Salata/Turchese						
2,5x20	Listello strutturato In Tinta	9,00	24							
FORMA SHAPE FORME FORM	ARTICOLO ITEM ARTICLE ARTIKEL	1° SCELTA PREZZO SFUSO 1° CHOICE LOOSE PRICE 1 CHOIX PRIX EN VRAC 1 WAHL PREIS LOSE	PZZ. PER SCAT. PCS PER BOX PCS PER BOÎTE ST. PRO KARTON	FORMA SHAPE FORME FORM	ARTICOLO ITEM ARTICLE ARTIKEL	1° SCELTA PREZZO SFUSO 1° CHOICE LOOSE PRICE 1 CHOIX PRIX EN VRAC 1 WAHL PREIS LOSE	PZZ. PER SCAT. PCS PER BOX PCS PER BOÎTE ST. PRO KARTON			
		PEZZI SPECIALI - Special pieces Pièces spéciales Spezielle Stücke	€ . pz							
	Torello 1	22,00	2		B.C. (Bullnose) 10x10	3,00	52			
	Spigolo 3	24,00	1			D.B.C. (Corner) 10x10	4,50	52		
	Angolo 6 (dx-sx)	24,00	2	Disponibili in tutti i colori - Available in all colours Disponibles dans toutes les couleurs - In allen Farben lieferbar						
	Battistraccio 2 linea	22,00	2							
	Battistraccio 5 Angolo	24,00	1	Disponibili nei colori: Available in the version of colours: - Disponibles dans les couleurs: - In den Farben lieferbar: Avorio/Banana/Bianco/Insalata/Melone						
	Battistraccio 4 (dx-sx)	24,00	1							

FORMA&FORMATO SHAPE & SIZE FORME ET FORMAT FORM UND FORMAT	ARTICOLO ITEM ARTICLE ARTIKEL	1° SCELTA PREZZO SFUSO 1° CHOIX PRIX EN VRAC 1 WAHL PREIS LOSE	COMM. PREZZO SFUSO COMM. LOOSE PRICE COMM. PRIX EN VRAC HW PREIS LOSE	1° SCELTA PREZZO RETE 1° CHOIX NET PRICE 1 WAHL PREIS NETZ	Pz x Box	Mq x Box	Kg x Box	Box x Pall.	Mq x Pall.	Kg x Pall.
		€ . mq	€ . mq	€ . mq	Imballaggio SFUSO LOOSE EN VRAC LOSE					
 10x10 ± 10 mm	 FIORITO BEIGE RAPOLANO BIANCO SCABAS NOCE MARBLE STYLE MIX (3 colori)	48,00	29,00	52,00	10x10					
		48,00	29,00	52,00	72	0,72	14,70	72	51,84	1.0745
 42,5x42,5 ± 10 mm	 FIORITO BEIGE RAPOLANO BIANCO SCABAS NOCE	40,00	24,00		42,5x42,5					
		40,00	24,00		7	1,26	26,00	48	60,48	1.264
 30,4x60,8 ± 10 mm	 FIORITO BEIGE RAPOLANO BIANCO SCABAS NOCE	44,00	26,00		30,4x60,8					
		44,00	26,00		7	1,29	29,00	40	51,60	1.176
 BATTISCOPA 8x42,5	 FIORITO BEIGE RAPOLANO BIANCO SCABAS NOCE	€ . ml	12,50		BATTISCOPA 8x42,5					
		12,50			Pz x Box	Ml x Box	Kg x Box	Box x Pall.	Ml x Pall.	Kg x Pall.
 BATTISCOPA 8x60,8	 FIORITO BEIGE RAPOLANO BIANCO SCABAS NOCE	€ . ml	14,50		BATTISCOPA 8x60,8					
		14,50			12	7,30	14,00	48	350,4	688
	MOSAICI Mosaics - Mosaïques - Mosaiken	€ . foglio sheet/feuille/Blatt								
 MOSAICO STYLE TESSERA 5x5 FOGLIO/SHEET/FEUILLE/BLATT 42,5x42,5	 FIORITO BEIGE RAPOLANO BIANCO SCABAS NOCE	22,00			Pz x Box	Mq x Box	Kg x Box	Box x Pall.	Mq x Pall.	Kg x Pall.
		22,00			3	0,54	11,40	32	17,28	381
 MOSAICO MIX STYLE TESSERA 5x5 FOGLIO/SHEET/FEUILLE/BLATT 42,5x42,5	 MIX Composto da: Fiorito Beige, Rapolano Bianco, Scabas Noce	23,00			Pz x Box	Mq x Box	Kg x Box	Box x Pall.	Mq x Pall.	Kg x Pall.
					3	0,54	11,40	32	17,28	381
 MOSAICO STYLE ACTUAL TESSERA 5x5 FOGLIO/SHEET/FEUILLE/BLATT 42,5x42,5	 FIORITO BEIGE RAPOLANO BIANCO SCABAS NOCE	32,00			Pz x Box	Mq x Box	Kg x Box	Box x Pall.	Mq x Pall.	Kg x Pall.
		32,00			3	0,54	11,40	32	17,28	381
 MOSAICO STYLE NIDO D'APE FOGLIO/SHEET/FEUILLE/BLATT 39x40	 SCABAS NOCE /FIORITO BEIGE SCABAS NOCE /RAPOLANO/BIANCO	39,00			Pz x Box	Mq x Box	Kg x Box	Box x Pall.	Mq x Pall.	Kg x Pall.
		39,00			3	0,47	9,92	32	15,04	333

FORMA SHAPE FORME FORM	FORMATO SIZE FORMAT FORMAT	ARTICOLO ITEM ARTICLE ARTIKEL	1° SCELTA PREZZO SFUSO 1° CHOICE LOOSE PRICE 1 CHOIX PRIX EN VRAC 1 WAHL PREIS LOSE € . pz	PZZ. PER SCAT. PCS PER BOX PCS PER BOÎTE ST. PRO KARTON	VERSIONE DI COLORE VERSION OF COLOUR VERSION COULEUR FARBEAUSFÜHRUNG	
		DECORAZIONI Decorations - Décors - Dekorationen				
	8x51	Treccia Nido d'Ape ml	35,00	5	Scabas Noce-Fiorito Beige Scabas Noce-Rapolano Bianco	
	10x10 5x20	Inserto Actual s/2 Treccia Actual	10,00 13,00	4 8	Fiorito Beige/Scabas Noce/Rapolano Bianco	
	10x10 20x20 5x20	Inserto Style s/3 Inserto Style s/1 Listello Style (*)	15,00 34,00 17,00	6 4 8	Unica Sole version - Unique - Einzige Ausführung	
	10x10 20x20 5x20	Inserto Tradition s/3 Inserto Tradition s/1 Listello Tradition (*)	15,00 34,00 17,00	6 4 8	Unica Sole version - Unique - Einzige Ausführung	
	10x10 20x20 5x30	Inserto Reinette s/3 Formella Reinette Treccia Reinette (*)	15,00 30,00 24,00	6 4 4	Unica Sole version - Unique - Einzige Ausführung	
	2,5x20	Sigaro Style	10,00	24	Fiorito Beige/Scabas Noce/Rapolano Bianco	
FORMA SHAPE FORME FORM	ARTICOLO ITEM ARTICLE ARTIKEL	1° SCELTA PREZZO SFUSO 1° CHOICE LOOSE PRICE 1 CHOIX PRIX EN VRAC 1 WAHL PREIS LOSE € . pz	PZZ. PER SCAT. PCS PER BOX PCS PER BOÎTE ST. PRO KARTON	FORMA SHAPE FORME FORM	ARTICOLO ITEM ARTICLE ARTIKEL	1° SCELTA PREZZO SFUSO 1° CHOICE LOOSE PRICE 1 CHOIX PRIX EN VRAC 1 WAHL PREIS LOSE € . pz
	PEZZI SPECIALI Special pieces - Pièces spéciales Spezielle Stücke				LAVELLI Basins - Éviers - Waschbecken	
	Frontale gradino con Lamella 4,3x30	27,00	4		Lavello Bagno da incasso ovale (56,5x46,5)	640,00
	Spigolo Frontale 4,3x4,3	10,00	1		Catino da incasso rotondo (ø47)	620,00
	V-cap (Bordo Tavolo 1) 6x20	11,00	4		Catino d'appoggio rotondo (ø39)	Monocolore 670,00 Bicolore 720,00
	C-cap (Spigolo 3 esterno) 3x6	14,00	1		Catino d'appoggio ovale (39,5x50)	Monocolore 720,00 Bicolore 770,00
	Sguscia Esterna 3x20	10,00	4		Lavello Cucina da incasso quadro (40x40)	600,00
	Unghia Esterna 3x3	11,00	1		Gocciolatoio da incasso (40x40)	420,00
	B.C. (Bullnose) 10x10	2,70	68	Disponibili in tutti i colori Available in all colours Disponibles dans toutes les couleurs In allen Farben lieferbar		
	D.B.C. (Corner) 10x10	3,70	68			
	Torello 1	22,00	2	Vedi note a pagina 52 - See notes on page 52 Voir notes à page 52 - Siehe Anmerkungen auf Seite 52		
	Spigolo 3	24,00	1			
	Angolo 6 (dx-sx)	24,00	2			
	Battistraccio 2 linea	22,00	2			
	Battistraccio 5 Angolo	24,00	1			
	Battistraccio 4 (sx)	24,00	1			
	Battistraccio 4 (dx)	24,00	1			

(*) QUESTO DECORO È SU ONYX. QUALSIASI IMPERFEZIONE O VARIAZIONE DI TONO È DA CONSIDERARE CARATTERISTICA DEL PRODOTTO.
THIS DECOR IS ON ONYX. ANY IMPERFECTION OR SHADE ALTERATION IS A CHARACTERISTIC OF THE STONE.
CE DECOR EST EN ONYX. TOUTE IMPERFECTION OU VARIATION DE TONALITÉ EST À CONSIDÉRER COMME CARACTÉRISTIQUE DU PRODUIT.
DIESE DEKOR BESTEHT AUS ONYX. JEDE FEHLERHAFTIGKEIT ODER WECHSEL TONALITÄT IST EINE.

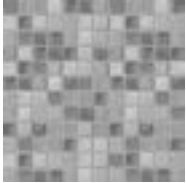
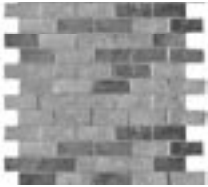
FORMA&FORMATO SHAPE & SIZE FORME ET FORMAT FORM UND FORMAT	ARTICOLO ITEM ARTICLE ARTIKEL	1° SCELTA PREZZO SFUSO 1° CHOICE LOOSE PRICE 1 CHOIX PRIX EN VRAC 1 WAHL PREIS LOSE € . mq	COMM. PREZZO SFUSO COMM. LOOSE PRICE COMM. PRIX EN VRAC HW PREIS LOSE € . mq		Pz x Box	Mq x Box	Kg x Box	Box x Pall.	Mq x Pall.	Kg x Pall.						
 10x10 ± 11 mm	 BIANCO CRISTAL BOTTICINO GIALLO VITTORIA NERO MARQUINIA PAGLIERINO RADICA ROSA CHIAMPO ROSSO PERSIA VERDE GUATEMALA CIOTTOLATO MIX GIALLO SFUSO (BOTTICINO-GIALLO VITTORIA-PAGLIERINO-RADICA) CIOTTOLATO MIX ROSA SFUSO (BOTTICINO-RADICA-ROSA CHIAMPO-ROSSO PERSIA)	47,00 47,00 47,00 47,00 47,00 47,00 47,00 47,00 47,00 47,00 54,00 54,00	28,00 28,00 28,00 28,00 28,00 28,00 28,00 28,00 28,00 28,00		Imballaggio SFUSO LOOSE EN VRAC LOSE 10x10						68	0,68	15,20	72	48,96	1.110
					 20x20 ± 11 mm	 BIANCO CRISTAL BOTTICINO GIALLO VITTORIA NERO MARQUINIA PAGLIERINO RADICA ROSA CHIAMPO ROSSO PERSIA VERDE GUATEMALA	42,00 42,00 42,00 42,00 42,00 42,00 42,00 42,00 42,00	25,00 25,00 25,00 25,00 25,00 25,00 25,00 25,00		Imballaggio SFUSO LOOSE EN VRAC LOSE 20x20						24
MOSAICI Mosaics - Mosaiques - Mosaiken		€ . foglio sheet/feuille/Blatt								Pz x Box	Mq x Box	Kg x Box	Box x Pall.	Mq x Pall.	Kg x Pall.	
 MOSAICO MIX MARBLE AGE TESSERA 2,2x2,2 FOGLIO/SHEET/FEUILLE/BLATT 30,5x30,5	MIX GIALLO Composto da: Giallo Vittoria - Botticino Radica MIX ROSA Composto da: Rosa Chiampo - Rosso Persia Botticino	21,00 21,00			5	0,46	9,00	60	27,60	556						
	 MOSAICO MIX MARBLE AGE MATTONCINO 2,2x4,8 FOGLIO/SHEET/FEUILLE/BLATT 30,5x30,5	MIX GIALLO Composto da: Giallo Vittoria - Botticino Radica MIX ROSA Composto da: Rosa Chiampo - Rosso Persia Botticino	20,00 20,00			5	0,46	9,00	60	27,60	556					

FORMA SHAPE FORME FORM	FORMATO SIZE FORMAT FORMAT	ARTICOLO ITEM ARTICLE ARTIKEL	1° SCELTA PREZZO SFUSO 1° CHOICE LOOSE PRICE 1 CHOIX PRIX EN VRAC 1 WAHL PREIS LOOSE € . pz	PZZ. PER SCAT. PCS PER BOX PCS PER BOÎTE ST. PRO KARTON	VERSIONE DI COLORE VERSION OF COLOUR VERSION COULEUR FARBEAUSFÜHRUNG
		DECORAZIONI Decorations - Décors - Dekorationen			
	10x10 7x20 3x20	Inserto Indios s/2 Fascia Indios Listello Indios	16,00 16,00 15,00	4 6 12	Unica Sole version - Unique - Einzige Ausführung
	10x10 20x20 5x20 2,5x20	Inserto Botticino s/3 Inserto Botticino (*) Listello Botticino Bombato Botticino	16,00 34,00 18,00 26,00	6 4 8 12	Beige/Verde
	10x10 20x20 5x20	Inserto Ottocento s/3 Inserto Ottocento (*) Listello Ottocento	16,00 34,00 18,00	6 4 8	Botticino
	10x10 5x10 3,5x20 10x10 10x10 10x15	Inserto Olimpo s/1 Listello Olimpo Listello Olimpo Fascia Olimpo Colonna Olimpo Girospecchio Olimpo	15,00 12,00 14,00 14,00 14,00 18,00	5 8 12 5 5 9	Beige/Rosa
	10x10 6x20 3x20 10x10 (lato 6)	Inserto Ravenna s/2 Fascia Ravenna Listello Ravenna Angolo Ravenna	16,00 16,00 15,00 16,00	4 6 12 5	Beige/Bianco
	10x10 20x30 5x20	Inserto Iris s/4 Formella Iris Listello Iris	15,00 75,00 14,00	4 1 8	Unica Sole version - Unique - Einzige Ausführung
	10x10 5x20	Inserto Genziana s/3 Listello Genziana	13,00 13,00	6 8	Rosso
	10x10 10x10 3x20	Inserto Grano s/2 Fascia Grano s/2 Listello Grano	16,00 15,00 14,00	4 4 12	Unica Sole version - Unique - Einzige Ausführung
	10x10 20x20 5x30	Inserto Reinette s/3 (*) Formella Reinette Treccia Reinette	15,00 30,00 24,00	6 4 4	Unica Sole version - Unique - Einzige Ausführung
	2,5x20	Sigaro Marble Age	9,00	24	Giallo Vittoria/Radica Rosso Persia/Verde Guatemala

(*) QUESTO DECORO È SU MARMO NATURALE. QUALSIASI IMPERFEZIONE O VARIAZIONE DI TONO È DA CONSIDERARE CARATTERISTICA DEL PRODOTTO.

(*) THIS IS A DECOR ON NATURAL MARBLE. ANY IMPERFECTION OR SHADE ALTERATION IS A CHARACTERISTIC OF THE STONE.







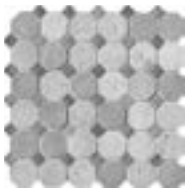
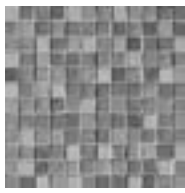

(*) CE DECOR EST EN VRAI MARBRE NATUREL: TOUTE IMPERFECTION OU VARIATION DE TONALITE EST A CONSIDERER COMME CARACTERISTIQUE DU PRODUIT.

(*) DIESE DEKORATION IST AUF NATÜRLICH MARMOR. JEDE FEHLERHAFTIGKEIT ODER WECHSEL TONALITÄT IST EINE.



















FORMA SHAPE FORME FORM	ARTICOLO ITEM ARTICLE ARTIKEL	1° SCELTA PREZZO SFUSO 1° CHOICE LOOSE PRICE 1 CHOIX PRIX EN VRAC 1 WAHL PREIS LOSE € . pz	PZZ. PER SCAT. PCS PER BOX PCS PER BOÎTE ST. PRO KARTON	FORMA SHAPE FORME FORM	ARTICOLO ITEM ARTICLE ARTIKEL	1° SCELTA PREZZO SFUSO 1° CHOICE LOOSE PRICE 1 CHOIX PRIX EN VRAC 1 WAHL PREIS LOSE € . pz
	PEZZI SPECIALI Special pieces - Pièces spéciales Spezielle Stücke				LAVELLI Basins - Éviers - Waschbecken	
	B.C. (Bullnose) 10x10	2,70	68		Lavello Bagno da incasso ovale (56,5x46,5)	640,00
Disponibili in tutti i colori - Available in all colours Disponibles dans toutes les couleurs - In allen Farben lieferbar						
	V-cap (Bordo Tavolo 1) 6x20	11,00	4		Catino da incasso rotondo (ø47)	620,00
	C-cap (Spigolo 3 esterno) 3x6	14,00	1		Catino d'appoggio rotondo (ø39)	Monocolore 670,00 Bicolore 720,00
	Q-round outside (Sguscia 2 esterna) 3x20	10,00	4		Catino d'appoggio ovale (39,5x50)	Monocolore 720,00 Bicolore 770,00
	Beak outside (Unghia 5 esterna) 3x3	11,00	1		Lavello Cucina da incasso quadro (40x40)	600,00
	Torello 1	22,00	2		Gocciolatoio da incasso (40x40)	420,00
	Spigolo 3	24,00	1			
	Angolo 6 (dx-sx)	24,00	2			
	Battistraccio 2 linea	22,00	2			
	Battistraccio 5 Angolo	24,00	1			
	Battistraccio 4 (sx)	24,00	1			
	Battistraccio 4 (dx)	24,00	1			
Disponibili nei colori: - Available in the version of colours: Disponibles dans les couleurs: - In den Farben lieferbar: Botticino/Giallo Vittoria/Paglierino/Radica/Rosa Chiampo/Rosso Persia				Disponibili in tutti i colori Available in all colours Disponibles dans toutes les couleurs In allen Farben lieferbar		
Vedi note a pagina 52 - See notes on page 52 - Voir notes à page 52 - Siehe Anmerkungen auf Seite 52						













FORMA&FORMATO SHAPE & SIZE FORME ET FORMAT FORME UND FORMAT		ARTICOLO ITEM ARTICLE ARTIKEL	1° SCELTA PREZZO SFUSO 1° CHOICE LOOSE PRICE 1 CHOIX PRIX EN VRAC 1 WAHL PREIS LOSE	COMM. PREZZO SFUSO COMM. LOOSE PRICE COMM. PRIX EN VRAC HW PREIS LOSE	Pz x Box	Mq x Box	Kg x Box	Box x Pall.	Mq x Pall.	Kg x Pall.	
<p>10x10 ± 10 mm</p>		ANTQUA AMBRA	46,00	27,00	Imballaggio SFUSO LOOSE EN VRAC LOSE						
		ANTQUA CORALLO	46,00	27,00	10x10						
		ANTQUA NOCE	46,00	27,00	72	0,72	15,50	72	51,84	1.132	
		ANTQUA TRAVERTINO	46,00	27,00							
FORMA SHAPE FORME FORM	FORMATO SIZE FORMAT FORMAT	ARTICOLO ITEM ARTICLE ARTIKEL	1° SCELTA PREZZO SFUSO 1° CHOICE LOOSE PRICE 1 CHOIX PRIX EN VRAC 1 WAHL PREIS LOSE	PZZ. PER SCAT. PCS PER BOX PCS PER BOÎTE ST. PRO KARTON	VERSIONE DI COLORE VERSION OF COLOUR VERSION COULEUR FARBEAUSFÜHRUNG						
		DECORAZIONI Decorations - Décors - Dekorationen									
	10x10	Formella Bacco Antiqua s/3	14,00	3	Unica Sole version - Unique - Einzige Ausführung						
	20x30	Formella Bacco Antiqua	78,00	1							
	5x20	Listello Bacco Antiqua	14,00	4							
	10x10	Inserto Domino Marmo s/1 (*)	17,00	5	Rosso						
	5x30	Treccia Domino Marmo	17,00	4							
	3x20	Listello Strutturato Antiqua	9,00	24	Corallo/Noce						
FORMA SHAPE FORME FORM	ARTICOLO ITEM ARTICLE ARTIKEL	1° SCELTA PREZZO SFUSO 1° CHOICE LOOSE PRICE 1 CHOIX PRIX EN VRAC 1 WAHL PREIS LOSE	PZZ. PER SCAT. PCS PER BOX PCS PER BOÎTE ST. PRO KARTON	FORMA SHAPE FORME FORM	ARTICOLO ITEM ARTICLE ARTIKEL	1° SCELTA PREZZO SFUSO 1° CHOICE LOOSE PRICE 1 CHOIX PRIX EN VRAC 1 WAHL PREIS LOSE	PZZ. PER SCAT. PCS PER BOX PCS PER BOÎTE ST. PRO KARTON				
		PEZZI SPECIALI - Special pieces Pièces spéciales Spezielle Stücke									
	Bordo Tavolo 1 5x10	10,00	4		Sguscia 2 3x10	9,00	4				
	Spigolo 3 esterno 3x5	14,00	1		Unghia 5 3x3	10,00	1				
	Angolo 6 interno 3x5	14,00	4		B.C. (Bullnose) 10x10	2,70	72				
					D.B.C. (Corner) 10x10	3,70	72				
Disponibili in tutti i colori - Available in all colours - Disponibles dans toutes les couleurs - In allen Farben lieferbar											
(*) QUESTO DECORO È SU MARMO NATURALE. QUALSIASI IMPERFEZIONE O VARIAZIONE DI TONO È DA CONSIDERARE CARATTERISTICA DEL PRODOTTO.											
(*) THIS IS A DECOR ON NATURAL MARBLE. ANY IMPERFECTION OR SHADE ALTERATION IS A CHARACTERISTIC OF THE STONE.											
(*) CE DECOR EST EN VRAI MARBRE NATUREL: TOUTE IMPERFECTION OU VARIATION DE TONALITE EST A CONSIDERER COMME CARACTERISTIQUE DU PRODUIT.											
(*) DIESE DEKORATION IST AUF NATÜRLICH MARMOR. JEDE FEHLERHAFTIGKEIT ODER WECHSEL TONALITÄT IST EINE.											

FORMA&FORMATO SHAPE & SIZE FORME ET FORMAT FORM UND FORMAT	ARTICOLO ITEM ARTICLE ARTIKEL	1° SCELTA PREZZO SFUSO 1° CHOIX LOOSE PRICE 1 WAHL PREIS LOSE	COMM. PREZZO SFUSO COMM. LOOSE PRICE COMM. PRIX EN VRAC HW PREIS LOSE	1° SCELTA PREZZO RETE 1° CHOIX NET PRICE 1 WAHL PREIS NETZ	Pz x Box	Mq x Box	Kg x Box	Box x Pall.	Mq x Pall.	Kg x Pall.
		€ . mq	€ . mq	€ . mq						
 10x10 ± 11 mm	 ABBADIA (sabbia) BORGIO (beige) FALCONI (rosa) GIOTTI (giallo) LA MORA (bianco) MORLUPO (arancio) PIAZZA VECCHIA (azzurro) SPADA (rosso) SPAVAGLI (verde)	47,00	28,00	53,00	Imballaggio SFUSO LOOSE EN VRAC LOSE 10x10					
		47,00	28,00		68	0,68	15,20	72	48,96	1.110
		47,00	28,00		Imballaggio RETE 30x40 9 Fogli Net 30x40 9 Sheets - Net 30x40 9 Feuille - Netz Blatt 30x40 9 Blätter 10x10					
		47,00	28,00		108	1,15	23,50	48	55,20	1.144
		47,00	28,00							
		47,00	28,00							
		47,00	28,00							
		47,00	28,00							
		55,00	58,00							
		55,00	58,00							
 10x20 ± 11 mm	 ABBADIA BORGIO FALCONI GIOTTI LA MORA MORLUPO PIAZZA VECCHIA SPADA SPAVAGLI	56,00	32,00		Pz x Box	Mq x Box	Kg x Box	Box x Pall.	Mq x Pall.	Kg x Pall.
		56,00	32,00		Imballaggio SFUSO LOOSE EN VRAC LOSE 10x20					
		56,00	32,00		24	0,48	11,50	108	54,00	1.258
		56,00	32,00							
		56,00	32,00							
		56,00	32,00							
		56,00	32,00							
		56,00	32,00							
		56,00	32,00							
		56,00	32,00							
 20x20 ± 11 mm	 ABBADIA BORGIO FALCONI GIOTTI LA MORA MORLUPO PIAZZA VECCHIA SPADA SPAVAGLI	42,00	25,00		Pz x Box	Mq x Box	Kg x Box	Box x Pall.	Mq x Pall.	Kg x Pall.
		42,00	25,00		Imballaggio SFUSO LOOSE EN VRAC LOSE 20x20					
		42,00	25,00		24	0,96	21,50	54	51,84	1.177
		42,00	25,00							
		42,00	25,00							
		42,00	25,00							
		42,00	25,00							
		42,00	25,00							
		42,00	25,00							
		42,00	25,00							
 5x10 ± 11 mm	 ABBADIA BORGIO FALCONI GIOTTI LA MORA MORLUPO PIAZZA VECCHIA SPADA SPAVAGLI	0,70	0,35		Imballaggio SFUSO LOOSE EN VRAC LOSE 5x10					
		0,70	0,35		25	-	-	-	-	-
		0,70	0,35							
		0,70	0,35							
		0,70	0,35							
		0,70	0,35							
		0,70	0,35							
		0,70	0,35							
		0,70	0,35							
		0,70	0,35							
 5x5 ± 11 mm	 ABBADIA BORGIO FALCONI GIOTTI LA MORA MORLUPO PIAZZA VECCHIA SPADA SPAVAGLI	0,70	0,40		Pz x Box	Mq x Box	Kg x Box	Box x Pall.	Mq x Pall.	Kg x Pall.
		0,70	0,40		Imballaggio SFUSO LOOSE EN VRAC LOSE 5x5					
		0,70	0,40		50	-	-	-	-	-
		0,70	0,40							
		0,70	0,40							
		0,70	0,40							
		0,70	0,40							
		0,70	0,40							
		0,70	0,40							
		0,70	0,40							

FORMA&FORMATO SHAPE & SIZE FORME ET FORMAT FORM UND FORMAT		ARTICOLO ITEM ARTICLE ARTIKEL	1° SCELTA PREZZO SFUSO 1° CHOICE LOOSE PRICE 1 CHOIX PRIX EN VRAC 1 WAHL PREIS LOSE								
		MOSAICI Mosaics - Mosaiques - Mosaiken	€ . foglio sheet/feuille/Blatt			Pz x Box	Mq x Box	Kg x Box	Box x Pall.	Mq x Pall.	Kg x Pall.
 MOSAICO BICOLORE QUINTANA OTTAGONINA 4x4 FOGLIO/SHEET/FEUILLE/BLATT 30,5x30,5		BICOLORE AZZURRO Composto da: Abbadia - Piazza Vecchia	27,00			5	0,46	9,00	60	27,60	556
		BICOLORE VERDE Composto da: Abbadia - Spavagli	27,00								
 MOSAICO MIX QUINTANA TESSERA 2,2x2,2 FOGLIO/SHEET/FEUILLE/BLATT 30,5x30,5		MIX CHIARO Composto da: Abbadia - Giotti - Borgo La Mora	21,00			Pz x Box	Mq x Box	Kg x Box	Box x Pall.	Mq x Pall.	Kg x Pall.
		MIX MEDIO Composto da: Abbadia - Borgo - Morlupo Spada	21,00			5	0,46	9,00	60	27,60	556
FORMA SHAPE FORME FORM	FORMATO SIZE FORMAT FORMAT	ARTICOLO ITEM ARTICLE ARTIKEL	1° SCELTA PREZZO SFUSO 1° CHOICE LOOSE PRICE 1 CHOIX PRIX EN VRAC 1 WAHL PREIS LOSE	PZZ. PER SCAT. PCS PER BOX PCS PER BOÎTE ST. PRO KARTON	VERSIONE DI COLORE VERSION OF COLOUR VERSION COULEUR FARBEAUSFÜHRUNG						
		DECORAZIONI Decorations - Décors - Dekorationen	€ . pz								
	10x10 20x20	Inserto Lamponi s/3 Formella Lamponi	15,00 32,00	6 4	Unica Sole version - Unique - Einzige Ausführung						
	5x20	Listello Cristalline	13,00	12	Azzurro/Smeraldo						
	10x10 20x30	Formella Bacco s/3 Formella Bacco	14,00 78,00	6 1	Chiara - Light- Clair - Hell						
	10x10	Inserto Flaminia s/2	15,00	4	Azzurro						
	10x10 20x30 5x20	Inserto Rione s/4 Formella Rione Listello Rione	16,00 62,00 17,00	4 1 12	Canapa/Cotto						
	10x10 5x20 3x20	Inserto Foligno s/3 Listello Foligno Listello Foligno	20,00 18,00 18,00	6 8 9	Blu/Verde						
	10x10 5x20	Inserto Umbria s/4 Treccia Umbria	10,00 13,00	4 8	Abbadia/Borgo/La Mora/Morlupo Piazza Vecchia/Spada/Spavagli						

FORMA SHAPE FORME FORM	FORMATO SIZE FORMAT FORMAT	ARTICOLO ITEM ARTICLE ARTIKEL	1° SCELTA PREZZO SFUSO 1° CHOICE LOOSE PRICE 1 CHOIX PRIX EN VRAC 1 WAHL PREIS LOSE € . pz	PZZ. PER SCAT. PCS PER BOX PCS PER BOÎTE ST. PRO KARTON	VERSIONE DI COLORE VERSION OF COLOUR VERSION COULEUR FARBEAUSFÜHRUNG	
		DECORAZIONI Decorations - Décors - Dekorationen				
	10x10 6,5x25 5x20 3x20	Inserto Deruta s/2 Fascia Deruta Treccia Deruta Listello Deruta	14,00 58,00 26,00 12,00	6 14 10 14	Azzurro	
	2,5x20	Listello strutturato Quintana	9,00	24	Abbadia/Borgo/Falconi/Giotti/Morlupo-Spada Piazza Vecchia/Spavagli	
FORMA SHAPE FORME FORM	ARTICOLO ITEM ARTICLE ARTIKEL	1° SCELTA PREZZO SFUSO 1° CHOICE LOOSE PRICE 1 CHOIX PRIX EN VRAC 1 WAHL PREIS LOSE € . pz	PZZ. PER SCAT. PCS PER BOX PCS PER BOÎTE ST. PRO KARTON	FORMA SHAPE FORME FORM	ARTICOLO ITEM ARTICLE ARTIKEL	1° SCELTA PREZZO SFUSO 1° CHOICE LOOSE PRICE 1 CHOIX PRIX EN VRAC 1 WAHL PREIS LOSE € . pz
	PEZZI SPECIALI Special pieces - Pièces spéciales Spezielle Stücke				LAVELLI Basins - Éviers - Waschbecken	
	V-cap (Bordo Tavolo 1) 6x20	11,00	4		Lavello Bagno da incasso ovale (56,5x46,5)	640,00
	C-cap (Spigolo 3 esterno) 3x6	14,00	1		Catino da incasso rotondo (ø47)	620,00
Disponibili nei colori: Available in the version of colours: - Disponibles dans les couleurs: - In den Farben lieferbar: Abbadia/Borgo/Morlupo						Catino d'appoggio rotondo (ø39) Monocolore 670,00 Bicolore 720,00
	B.C. (Bullnose) 10x10	2,70	68		Catino d'appoggio ovale (39,5x50) Monocolore 720,00 Bicolore 770,00	
	D.B.C. (Corner) 10x10	3,70	68		Lavello Cucina da incasso quadro (40x40)	600,00
	Torello 1	22,00	2		Gocciolatoio da incasso (40x40)	420,00
	Spigolo 3	24,00	1			
	Angolo 6 (dx-sx)	24,00	2			
	Battistraccio 2 linea	22,00	2			
	Battistraccio 5 Angolo	24,00	1			
	Battistraccio 4 (sx)	24,00	1			
	Battistraccio 4 (dx)	24,00	1			
Disponibili in tutti i colori - Available in all colours - Disponibles dans toutes les couleurs - In allen Farben lieferbar						
Vedi note a pagina 52 - See notes on page 52 - Voir notes à page 52 - Siehe Anmerkungen auf Seite 52						

FORMA&FORMATO SHAPE & SIZE FORME ET FORMAT FORME UND FORMAT		ARTICOLO ITEM ARTICLE ARTIKEL	1° SCELTA PREZZO SFUSO 1° CHOICE LOOSE PRICE 1 CHOIX PRIX EN VRAC 1 WAHL PREIS LOSE	COMM. PREZZO SFUSO COMM. LOOSE PRICE COMM. PRIX EN VRAC HW PREIS LOSE	Pz x Box	Mq x Box	Kg x Box	Box x Pall.	Mq x Pall.	Kg x Pall.
 10x10 ± 10 mm		DAKAR ERG GARBI GHIBLI MAGHREB MISTRAL TUAREG	46,00 46,00 46,00 46,00 46,00 46,00 46,00	28,00 28,00 28,00 28,00 28,00 28,00 28,00	Imballaggio SFUSO LOOSE EN VRAC LOSE 10x10 72 0,72 15,50 72 51,84 1.132					
FORMA SHAPE FORME FORM	FORMATO SIZE FORMAT FORMAT	ARTICOLO ITEM ARTICLE ARTIKEL	1° SCELTA PREZZO SFUSO 1° CHOICE LOOSE PRICE 1 CHOIX PRIX EN VRAC 1 WAHL PREIS LOSE	PZZ. PER SCAT. PCS PER BOX PCS PER BOÎTE ST. PRO KARTON	VERSIONE DI COLORE VERSION OF COLOUR VERSION COULEUR FARBEAUSFÜHRUNG					
		DECORAZIONI Decorations - Décors - Dekorationen								
	10x10 5x20	Formella Miraggio s/4 Listello Miraggio	15,00 14,00	4 8	Unica Sole version - Unique - Einzige Ausführung					
	10x10 6x20 3x20	Formella Deserti s/1 Listello Deserti	16,00 16,00 13,00	5 8 12	Unica Sole version - Unique - Einzige Ausführung					
	10x10 5x20	Inserto Harem s/8 Treccia Harem	12,00 13,00	8 8	Unica Sole version - Unique - Einzige Ausführung					
	10x10 5x30	Inserto Domino Marmo s/1 Treccia Domino Marmo (*)	17,00 17,00	5 4	Rosso					
	3x20	Listello strutturato Deserti	9,00	24	Dakar/Erg/Garbi/Ghibli/Maghreb/Tuareg					
FORMA SHAPE FORME FORM	ARTICOLO ITEM ARTICLE ARTIKEL	1° SCELTA PREZZO SFUSO 1° CHOICE LOOSE PRICE 1 CHOIX PRIX EN VRAC 1 WAHL PREIS LOSE	PZZ. PER SCAT. PCS PER BOX PCS PER BOÎTE ST. PRO KARTON	FORMA SHAPE FORME FORM	ARTICOLO ITEM ARTICLE ARTIKEL	1° SCELTA PREZZO SFUSO 1° CHOICE LOOSE PRICE 1 CHOIX PRIX EN VRAC 1 WAHL PREIS LOSE				
	PEZZI SPECIALI - Special pieces Pièces spéciales Spezielle Stücke				LAVELLI Basins - Éviers - Waschbecken					
	B.C. (Bullnose) 10x10	2,70	72		Lavello Bagno da incasso ovale (56,5x46,5)	640,00				
	D.B.C. (Corner) 10x10	3,70	72							
Disponibili in tutti i colori - Available in all colours - Disponibles dans toutes les couleurs - In allen Farben lieferbar										
	Torello 1	22,00	2		Lavello Cucina da incasso quadro (40x40)	600,00				
	Spigolo 3	24,00	1							
	Angolo 6 (dx-sx)	24,00	2		Gocciolatoio da incasso (40x40)	420,00				
	Battistraccio 2 linea	22,00	2							
	Battistraccio 5 Angolo	24,00	1							
	Battistraccio 4 (sx)	24,00	1							
	Battistraccio 4 (dx)	24,00	1							
Disponibili nei colori: - Available in the version of colours: - Disponibles dans les couleurs: In den Farben lieferbar: Dakar/Erg/Ghibli/Maghreb/Tuareg				Disponibili in tutti i colori - Available in all colours Disponibles dans toutes les couleurs - In allen Farben lieferbar						
(*) QUESTO DECORO È SU MARMO NATURALE. QUALSIASI IMPERFEZIONE O VARIAZIONE DI TONO È DA CONSIDERARE CARATTERISTICA DEL PRODOTTO.										
(*) THIS IS A DECOR ON NATURAL MARBLE. ANY IMPERFECTION OR SHADE ALTERATION IS A CHARACTERISTIC OF THE STONE.										
(*) CE DECOR EST EN VRAI MARBRE NATUREL: TOUTE IMPERFECTION OU VARIATION DE TONALITE EST A CONSIDERERER COMME CARACTERISTIQUE DU PRODUIT.										
(*) DIESE DEKORATION IST AUF NATÜRLICH MARMOR. JEDE FEHLERHAFTIGKEIT ODER WECHSEL TONALITÄT IST EINE.										









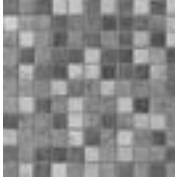

FORMA&FORMATO SHAPE & SIZE FORME ET FORMAT FORM UND FORMAT	ARTICOLO ITEM ARTICLE ARTIKEL	1° SCELTA PREZZO SFUSO	COMM. PREZZO SFUSO	Pz x Box	Mq x Box	Kg x Box	Box x Pall.	Mq x Pall.	Kg x Pall.
		1° CHOIX LOOSE PRICE	COMM. LOOSE PRICE						
		1 WAHL PREIS LOSE	COMM. PREIS EN VRAC HW PREIS LOSE						
		€ . mq	€ . mq						
 10x10 ± 11 mm	 AGATA (verde) CALCIO (bianco beige) GESSO (bianco grigio) MINIO (rosso) NITRO (blu) ORO (giallo) PIOMBO (antracite) SALE (bianco verde) TALCO (bianco azzurro)	47,00	28,00	Imballaggio SFUSO LOOSE EN VRAC LOSE					
		47,00	28,00	10x10					
		47,00	28,00	68	0,68	15,20	72	48,96	1.110
		47,00	28,00						
		47,00	28,00						
		47,00	28,00						
		47,00	28,00						
		47,00	28,00						
		47,00	28,00						
 10x20 ± 11 mm	 AGATA (verde) CALCIO (bianco beige) GESSO (bianco grigio) MINIO (rosso) NITRO (blu) ORO (giallo) PIOMBO (antracite) SALE (bianco verde) TALCO (bianco azzurro)	56,00	32,00	Imballaggio SFUSO LOOSE EN VRAC LOSE					
		56,00	32,00	10x20					
		56,00	32,00	25	0,50	11,50	108	54,00	1.258
		56,00	32,00						
		56,00	32,00						
		56,00	32,00						
		56,00	32,00						
		56,00	32,00						
		56,00	32,00						
 20x20 ± 11 mm	 AGATA (verde) CALCIO (bianco beige) GESSO (bianco grigio) MINIO (rosso) NITRO (blu) ORO (giallo) PIOMBO (antracite) SALE (bianco verde) TALCO (bianco azzurro)	42,00	25,00	Imballaggio SFUSO LOOSE EN VRAC LOSE					
		42,00	25,00	20x20					
		42,00	25,00	24	0,96	21,00	54	51,84	1.150
		42,00	25,00						
		42,00	25,00						
		42,00	25,00						
		42,00	25,00						
		42,00	25,00						
		42,00	25,00						
 20x20 PENTAGONO (*) ± 11 mm	 PENTAGONO AGATA (verde) PENTAGONO CALCIO (bianco beige) PENTAGONO GESSO (bianco grigio) PENTAGONO MINIO (rosso) PENTAGONO NITRO (blu) PENTAGONO ORO (giallo) PENTAGONO PIOMBO (antracite) PENTAGONO SALE (bianco verde) PENTAGONO TALCO (bianco azzurro)	56,00	32,00	Imballaggio SFUSO LOOSE EN VRAC LOSE					
		56,00	32,00	20x20 Pentagono					
		56,00	32,00	24	0,93	21,00	54	50,22	1.150
		56,00	32,00						
		56,00	32,00						
		56,00	32,00						
		56,00	32,00						
		56,00	32,00						
		56,00	32,00						
 5x10 ± 11 mm	 AGATA (verde) CALCIO (bianco beige) GESSO (bianco grigio) MINIO (rosso) NITRO (blu) ORO (giallo) PIOMBO (antracite) SALE (bianco verde) TALCO (bianco azzurro)	0,70	0,35	Imballaggio SFUSO LOOSE EN VRAC LOSE					
		0,70	0,35	5x10					
		0,70	0,35	25	-	-	-	-	-
		0,70	0,35						
		0,70	0,35						
		0,70	0,35						
		0,70	0,35						
		0,70	0,35						
		0,70	0,35						
 5x5 ± 11 mm	 AGATA (verde) CALCIO (bianco beige) GESSO (bianco grigio) MINIO (rosso) NITRO (blu) ORO (giallo) PIOMBO (antracite) SALE (bianco verde) TALCO (bianco azzurro)	0,70	0,40	Imballaggio SFUSO LOOSE EN VRAC LOSE					
		0,70	0,40	5x5					
		0,70	0,40	50	-	-	-	-	-
		0,70	0,40						
		0,70	0,40						
		0,70	0,40						
		0,70	0,40						
		0,70	0,40						
		0,70	0,40						

(*) Possibile abbinamento con: Tozzetto 5x5 (tutti i colori); Tozzetto Fuel 5x5.
 (*) Possible matchable with: Tozzetto 5x5 (all colours); Tozzetto Fuel 5x5.
 (*) Possible assortissement avec: Tozzetto 5x5 (toutes les couleurs); Tozzetto Fuel 5x5.
 (*) Möglich kombiniert mit: Tozzetto 5x5 (alle Farben); Tozzetto Fuel 5x5.

FORMA&FORMATO SHAPE & SIZE FORME ET FORMET FORM UND FORMAT		ARTICOLO ITEM ARTICLE ARTIKEL	1° SCELTA PREZZO SFUSO 1° CHOICE LOOSE PRICE 1 CHOIX PRIX EN VRAC 1 WAHL PREIS LOSE							
		MOSAICI Mosaics - Mosaiques - Mosaiken	€ . foglio sheet/feuille/Blatt							
<p>MOSAICO MIX FUEL TESSERA 2,2x2,2 FOGLIO/SHEET/FEUILLE/BLATT 30,5x30,5</p>		MIX DARK Composto da: Agata - Piombo - Sale	21,00		Pz x Box	Mq x Box	Kg x Box	Box x Pall.	Mq x Pall.	Kg x Pall.
		MIX LIGHT Composto da: Minio - Oro - Calcio	21,00		5	0,46	9,00	60	27,60	556
		MIX SKY Composto da: Nitro - Piombo - Talco	21,00							
FORMA SHAPE FORME FORM	FORMATO SIZE FORMAT FORMAT	ARTICOLO ITEM ARTICLE ARTIKEL	1° SCELTA PREZZO SFUSO 1° CHOICE LOOSE PRICE 1 CHOIX PRIX EN VRAC 1 WAHL PREIS LOSE	PZZ. PER SCAT. PCS PER BOX PCS PER BOÎTE ST. PRO KARTON	VERSIONE DI COLORE VERSION OF COLOUR VERSION COULEUR FARBEAUSFÜHRUNG					
		DECORAZIONI Decorations - Décors - Dekorationen	€ . pz							
	5x20	Listello Impero	19,00	8	Azzurro/Beige					
	10x10 5x20 2,2x20 5x5	Inserto Fuel s/4 Treccia Fuel Listello Fuel Tozzetto Fuel s/4	11,00 14,00 10,00 5,00	4 8 6 20	Blu/Giallo/Grigio/Rosso/Verde					
	10x10 10x10 5x20 5x20 2,2x20	Inserto Stemmi A (rotondo) s/4 Inserto Stemmi B (quadrato) s/4 Treccia Stemmi A (rotondo) s/2 Treccia Stemmi B (quadrato) s/2 Listello Stemmi s/2	12,00 12,00 15,00 15,00 10,00	4 4 8 8 16	Unica Sole version - Unique - Einzige Ausführung					
	10x10 20x20 3x20 8x20 10x10 (lato 8) 8x25 13,5x13	Inserto Appia s/1 Inserto Appia Listello Appia Fascia Appia Angolo Appia Girospecchio Appia Chiave di volta Appia	14,00 44,00 13,00 14,00 14,00 17,00 24,00	5 4 12 10 5 4 1	Blu/Rosso					
	10x10 3x20	Inserto Pitrezza s/3 Treccia Pitrezza (*)	40,00 32,00	6 12	Blu					
	10x10 20x40 10x10 3x20	Inserto Grappoli s/2 Formella Grappoli Fascia Grappoli s/2 Listello Grappoli	16,00 86,00 16,00 15,00	4 1 4 12	Giallo/Verde					
	10x10 20x20 5x20	Inserto Travertino s/3 Inserto Travertino (*) Listello Travertino	16,00 36,00 18,00	6 4 8	Unica Sole version - Unique - Einzige Ausführung					
	10x10 20x20 5x20 3x20	Inserto Arance s/1 Inserto Arance Listello Arance Listello Arance	15,00 48,00 14,00 13,00	5 4 8 12	Unica Sole version - Unique - Einzige Ausführung					
	2,5x20	Sigaro Fuel	9,00	24	Agata/Minio/Nitro/Oro/Piombo					
<p>(*) QUESTO DECORO È SU MARMO NATURALE. QUALSIASI IMPERFEZIONE O VARIAZIONE DI TONO È DA CONSIDERARE CARATTERISTICA DEL PRODOTTO.</p> <p>(*) THIS IS A DECOR ON NATURAL MARBLE. ANY IMPERFECTION OR SHADE ALTERATION IS A CHARACTERISTIC OF THE STONE.</p> <p>(*) CE DECOR EST EN VRAI MARBRE NATUREL: TOUTE IMPERFECTION OU VARIATION DE TONALITE EST A CONSIDERERER COMME CARACTERISTIQUE DU PRODUIT.</p> <p>(*) DIESE DEKORATION IST AUF NATÜRLICH MARMOR. JEDE FEHLERHAFTIGKEIT ODER WECHSEL TONALITÄT IST EINE.</p>										

FORMA SHAPE FORME FORM	ARTICOLO ITEM ARTICLE ARTIKEL	1° SCELTA PREZZO SFUSO 1° CHOICE LOOSE PRICE 1 CHOIX PRIX EN VRAC 1 WAHL PREIS LOSE €. pz	PZZ. PER SCAT. PCS PER BOX PCS PER BOÎTE ST. PRO KARTON	FORMA SHAPE FORME FORM	ARTICOLO ITEM ARTICLE ARTIKEL	1° SCELTA PREZZO SFUSO 1° CHOICE LOOSE PRICE 1 CHOIX PRIX EN VRAC 1 WAHL PREIS LOSE €. pz
	PEZZI SPECIALI Special pieces - Pièces spéciales Spezielle Stücke				LAVELLI Basins - Éviers - Waschbecken	
	V-cap (Bordo Tavolo 1) 6x20	11,00	4		Lavello Bagno da incasso ovale (56,5x46,5)	640,00
	C-cap (Spigolo 3 esterno) 3x6	14,00	1		Catino da incasso rotondo (ø47)	620,00
	Q-round outside (Sguscia 2 esterna) 3x20	10,00	4		Catino d'appoggio rotondo (ø39)	Monocolore 670,00 Bicolore 720,00
	Beak outside (Unghia 5 esterna) 3x3	11,00	1		Catino d'appoggio ovale (39,5x50)	Monocolore 720,00 Bicolore 770,00
Disponibili nei colori: - Available in the version of colours: Disponibles dans les couleurs: - In den Farben lieferbar: Agata/Calcio/Minio/Nitro/Oro						
	B.C. (Bullnose) 10x10	2,70	68		Lavello Cucina da incasso quadro (40x40)	600,00
	D.B.C. (Corner) 10x10	3,70	68		Gocciolatoio da incasso (40x40)	420,00
Disponibili nei colori: - Available in the version of colours: Disponibles dans les couleurs: - In den Farben lieferbar: Calcio/Minio/Nitro/Oro/Sale/Talco						
	Torello 1	22,00	2			
	Spigolo 3	24,00	1			
	Angolo 6 (dx-sx)	24,00	2			
	Battistraccio 2 linea	22,00	2			
	Battistraccio 5 Angolo	24,00	1			
	Battistraccio 4 (sx)	24,00	1			
	Battistraccio 4 (dx)	24,00	1			
Disponibili nei colori: - Available in the version of colours: Disponibles dans les couleurs: - In den Farben lieferbar: Agata/Calcio/Minio/Nitro/Oro/Talco						
Vedi note a pagina 52 - See notes on page 52 - Voir notes à page 52 - Siehe Anmerkungen auf Seite 52						



FORMA&FORMATO SHAPE & SIZE FORME ET FORMAT FORM UND FORMAT		ARTICOLO ITEM ARTICLE ARTIKEL	1° SCELTA PREZZO SFUSO 1° CHOICE LOOSE PRICE 1 CHOIX PRIX EN VRAC 1 WAHL PREIS LOSE	COMM. PREZZO SFUSO COMM. LOOSE PRICE COMM. PRIX EN VRAC HW PREIS LOSE	Pz x Box	Mq x Box	Kg x Box	Box x Pall.	Mq x Pall.	Kg x Pall.
 10x10 ± 10 mm		 AMBER SAND TERRA	46,00 46,00 46,00	28,00 28,00 28,00	Imballaggio SFUSO LOOSE EN VRAC LOSE 10x10 72 0,72 15,50 72 51,84 1.132					
 MOS. MIX QUARRY STONE TESSERA 2,2x2,2 FOGLIO/SHEET/FEUILLE/BLATT 30,5x30,5		MOSAICI Mosaics - Mosaiques - Mosaiken	€ . foglio sheet/feuille/Blatt	21,00	5	0,46	9,00	60	27,60	556
FORMA SHAPE FORME FORM	FORMATO SIZE FORMAT FORMAT	ARTICOLO ITEM ARTICLE ARTIKEL	1° SCELTA PREZZO SFUSO 1° CHOICE LOOSE PRICE 1 CHOIX PRIX EN VRAC 1 WAHL PREIS LOSE	PZZ. PER SCAT. PCS PER BOX PCS PER BOÎTE ST. PRO KARTON	VERSIONE DI COLORE VERSION OF COLOUR VERSION COULEUR FARBEAUSFÜHRUNG					
		DECORAZIONI Decorations - Décors - Dekorationen								
  	10x10 20x20 5x20 2,5x20	Inserto Botticino s/3 Inserto Botticino (*) Listello Botticino Bombato Botticino	16,00 34,00 18,00 26,00	6 4 8 12	Beige					
	10x10 5x30	Inserto Domino Marmo s/1 (*) Treccia Domino Marmo	17,00 17,00	5 4	Rosso					
	10x10 10x10 3x20 20x40	Inserto Grappoli s/2 Fascia Grappoli s/2 Listello Grappoli Formella Grappoli	16,00 16,00 15,00 86,00	4 4 12 1	Giallo/Verde					
FORMA SHAPE FORME FORM	ARTICOLO ITEM ARTICLE ARTIKEL	1° SCELTA PREZZO SFUSO 1° CHOICE LOOSE PRICE 1 CHOIX PRIX EN VRAC 1 WAHL PREIS LOSE	PZZ. PER SCAT. PCS PER BOX PCS PER BOÎTE ST. PRO KARTON	QUESTO DECORO È SU MARMO NATURALE. QUALSIASI IMPERFEZIONE O VARIAZIONE DI TONO È DA CONSIDERARE CARATTERISTICA DEL PRODOTTO. (*) THIS IS A DECOR ON NATURAL MARBLE. ANY IMPERFECTION OR SHADE ALTERATION IS A CHARACTERISTIC OF THE STONE. (*) CE DECOR EST EN VRAI MARBRE NATUREL: TOUTE IMPERFECTION OU VARIATION DE TONALITE EST A CONSIDERERER COMME CARACTERISTIQUE DU PRODUIT. (*) DIESE DEKORATION IST AUF NATÜRLICH MARMOR. JEDE FEHLERHAFTIGKEIT ODER WECHSEL TONALITÄT IST EINE.						
	PEZZI SPECIALI Special pièces - Pièces spéciales Spezielle Stücke	€ . pz								
    	v-cap (Bordo Tavolo 1) 6x10 c-cap (Spigolo 3 esterno) 3x6 Angolo 6 interno (dx-sx) 6x10 q-round inside-outside (Sguscia 2 interna-esterna) 3x10 beak inside-outside (Unghia 5 interna-esterna) 3x3	10,00 13,00 11,00 7,00 10,00	4 1 2 4 1							
Disponibili in tutti i colori - Available in all colours Disponibles dans toutes les couleurs - In allen Farben lieferbar										

FORMA&FORMATO SHAPE & SIZE FORME ET FORMAT FORME UND FORMAT		ARTICOLO ITEM ARTICLE ARTIKEL	1° SCELTA PREZZO SFUSO 1° CHOICE LOOSE PRICE 1 CHOIX PRIX EN VRAC 1 WAHL PREIS LOSE € . mq	COMM. PREZZO SFUSO COMM. LOOSE PRICE COMM. PRIX EN VRAC HW PREIS LOSE € . mq	Pz x Box	Mq x Box	Kg x Box	Box x Pall.	Mq x Pall.	Kg x Pall.	
 10x10 ± 10,5 mm		CALEIDOS AVORIO	46,00	28,00	Imballaggio SFUSO LOOSE EN VRAC LOSE						
		CALEIDOS BIANCO	46,00	28,00	10x10						
		CALEIDOS DIAMANTE	46,00	28,00	68	0,68	15,20	60	40,80	928	
		CALEIDOS GIALLO	46,00	28,00							
		CALEIDOS LAVANDA	46,00	28,00							
		CALEIDOS MARINA	46,00	28,00							
 20x20 ± 10,5 mm		CALEIDOS AVORIO	46,00	28,00	Imballaggio SFUSO LOOSE EN VRAC LOSE						
		CALEIDOS DIAMANTE	46,00	28,00	20x20						
		CALEIDOS GIALLO	46,00	28,00	24	0,96	21,00	54	51,84	1.150	
		CALEIDOS MARINA	46,00	28,00							
FORMA SHAPE FORME FORM	FORMATO SIZE FORMAT FORMAT	ARTICOLO ITEM ARTICLE ARTIKEL	1° SCELTA PREZZO SFUSO 1° CHOICE LOOSE PRICE 1 CHOIX PRIX EN VRAC 1 WAHL PREIS LOSE € . pz	PZZ. PER SCAT. PCS PER BOX PCS PER BOÎTE ST. PRO KARTON	VERSIONE DI COLORE VERSION OF COLOUR VERSION COULEUR FARBEAUSFÜHRUNG						
		DECORAZIONI Decorations - Décors - Dekorationen									
	20x20	Inserto Crù angolo s/4	16,00	4	Avorio/Diamante						
	20x20	Inserto Crù s/1	16,00	4							
	10x10	Inserto Crù s/4	12,00	4							
	20x20	Inserto Radica s/2	20,00	4	Avorio						
	20x20	Inserto Lustro s/2	20,00	4	Avorio/Diamante						
	10x10	Inserto Lustro s/3	14,00	6							
	20x20	Inserto Leaf s/1	16,00	4	Avorio/Diamante						
	10x10	Inserto Leaf s/1	12,00	5							
	20x20	Inserto Lignes s/1	14,00	4	Avorio/Diamante						
	10x10	Inserto Lignes s/1	13,00	5							
	10x10	Formella Margherita s/3	13,00	6	Beige/Blu						
	5x20	Listello Margherita	13,00	8							
	10x10	Formella Bacco Lucida s/3	14,00	6	Unica Sole version - Unique - Einzige Ausführung						
	20x30	Formella Bacco Lucida	78,00	1							
5x20	Listello Bacco Lucida	14,00	4								
10x10	Inserto Campo Lavanda s/3	13,00	6	Unica Sole version - Unique - Einzige Ausführung							
20x30	Formella Campo Lavanda	72,00	1								
5x20	Listello Campo Lavanda	14,00	8								
10x10	Inserto Frutta s/2	15,00	4	Unica Sole version - Unique - Einzige Ausführung							
20x30	Formella Frutta	78,00	1								
5x20	Listello Frutta	14,00	8								
	3x20	Listello strutturato Caleidos	9,00	24	Giallo/Marina						



FORMA SHAPE FORME FORM	ARTICOLO ITEM ARTICLE ARTIKEL	1° SCELTA PREZZO SFUSO 1° CHOICE LOOSE PRICE 1 CHOIX PRIX EN VRAC 1 WAHL PREIS LOSE €. pz	PZZ. PER SCAT. PCS PER BOX PCS PER BÖTE ST. PRO KARTON	FORMA SHAPE FORME FORM	ARTICOLO ITEM ARTICLE ARTIKEL	1° SCELTA PREZZO SFUSO 1° CHOICE LOOSE PRICE 1 CHOIX PRIX EN VRAC 1 WAHL PREIS LOSE €. pz
	PEZZI SPECIALI Special pieces - Pièces spéciales Spezielle Stücke				LAVELLI Basins - Éviers - Waschbecken	
	B.C. (Bullnose) 10x10	2,70	68		Lavello Bagno da incasso ovale (56,5x46,5)	640,00
	D.B.C. (Corner) 10x10	3,70	68		Catino da incasso rotondo (ø47)	620,00
Disponibili in tutti i colori - Available in all colours Disponibles dans toutes les couleurs - In allen Farben lieferbar						
	Torello 1	22,00	2		Catino d'appoggio rotondo (ø39)	Monocolore 670,00 Bicolore 720,00
	Spigolo 3	24,00	1		Catino d'appoggio ovale (39,5x50)	Monocolore 720,00 Bicolore 770,00
	Angolo 6 (dx-sx)	24,00	2		Lavello Cucina da incasso quadro (40x40)	600,00
	Battistraccio 2 linea	22,00	2		Gocciolatoio da incasso (40x40)	420,00
	Battistraccio 5 Angolo	24,00	1			
	Battistraccio 4 (sx)	24,00	1			
	Battistraccio 4 (dx)	24,00	1			
Disponibili nei colori: Available in the version of colours: - Disponibles dans les couleurs: In den Farben lieferbar: Avorio/Bianco/Giallo//Marina				Disponibili in tutti i colori - Available in all colours Disponibles dans toutes les couleurs - In allen Farben lieferbar		
Vedi note a pagina 52 - See notes on page 52 - Voir notes à page 52 - Siehe Anmerkungen auf Seite 52						



FORMA&FORMATO SHAPE & SIZE FORME ET FORMAT FORM UND FORMAT	ARTICOLO ITEM ARTICLE ARTIKEL	1° SCELTA PREZZO SFUSO 1° CHOICE LOOSE PRICE 1 CHOIX PRIX EN VRAC 1 WAHL PREIS LOSE €. mq	COMM. PREZZO SFUSO COMM. LOOSE PRICE COMM. PRIX EN VRAC HW PREIS LOSE €. mq	Pz x Box	Mq x Box	Kg x Box	Box x Pall.	Mq x Pall.	Kg x Pall.
 10x10 ± 10 mm	ORO	48,00	29,00	Imballaggio SFUSO LOOSE EN VRAC LOSE					
	PERLA	48,00	29,00	10x10					
	PIRITE	48,00	29,00	72	0,72	15,50	72	51,84	1.132
	TITANIO	48,00	29,00						
 10x50 ± 10 mm	ORO	52,00	31,00	Imballaggio SFUSO LOOSE EN VRAC LOSE					
	PERLA	52,00	31,00	10x50					
	PIRITE	52,00	31,00	10	0,50	10,50	90	45,00	940
	TITANIO	52,00	31,00	19	0,95	19,00	48	45,60	928
FORMA SHAPE FORME FORM	FORMATO SIZE FORMAT FORMAT	ARTICOLO ITEM ARTICLE ARTIKEL	1° SCELTA PREZZO SFUSO 1° CHOICE LOOSE PRICE 1 CHOIX PRIX EN VRAC 1 WAHL PREIS LOSE €. pz	PZZ. PER SCAT. PCS PER BOX PCS PER BÖTE ST. PRO KARTON	VERSIONE DI COLORE VERSION OF COLOUR VERSION COULEUR FARBEAUSFÜHRUNG				
		DECORAZIONI Decorations - Décors - Dekorationen							
	3,5x30	Fascia Concept	13,00	8	Black/Coffee				
	10x10	Inserto Breakfast s/2	14,00	4	Grigio				
	5x30	Listello Breakfast	15,00	8	Fucsia				
	1x30	Matita Vetro	10,00	8	Alluminio				
	3x30	Fascia Morse	14,00	8					

LAVELLI - BASINS - ÉVIERS - WASCHBECKEN - РАКОВИНЫ gres

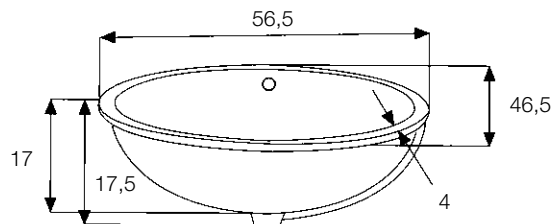

Lavello Bagno da incasso ovale 56,5x46,5 cm
Foro per incasso 41x52 cm
Foro per piletta standard

Completi di
scarichi in PVC

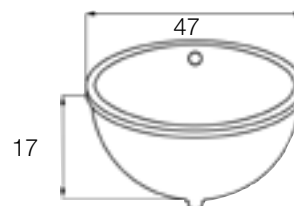

Catino da incasso rotondo Ø 47 cm
Foro per incasso Ø 42 cm
Foro per piletta standard

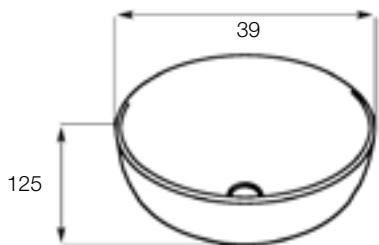

Catino d'appoggio rotondo Ø 39 cm
Foro per piletta standard

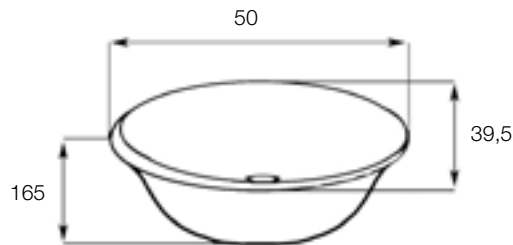

Catino d'appoggio ovale 39,5x50 cm
Foro per piletta standard

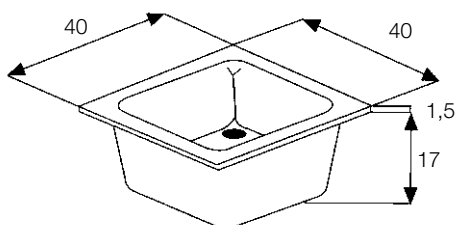

Lavello cucina da incasso quadro 40x40 cm
Foro per incasso 38,5x38,5 cm
Foro per piletta standard

Completi di
scarichi in PVC

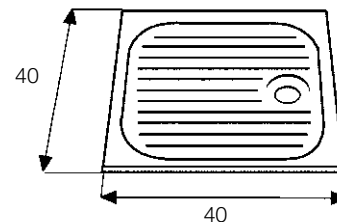

Gocciolatoio da incasso 40x40 cm
Foro per piletta standard

PEZZI SPECIALI - LAVELLI: l'impiego di un supporto greificato e la totale esecuzione manuale della smaltatura determinano possibili differenze di tonalità più o meno accentuate in relazione allo smalto e al prodotto.

SPECIAL PIECES - BASINS: the use of a special clay base and the manual glazing application could determine (or cause) possible shading differences more or less visible depending on the glaze used and/or on the product itself.

PIÈCES SPÉCIALES - ÉVIERS: l'utilisation d'un support grésé et la réalisation entièrement manuelle de l'émaillage peuvent produire des écarts de tonalité plus ou moins accentués selon l'émail et le produit.

SPEZIELLE STÜCKE - WASCHBECKEN: der Gebrauch eines Gresträgers und die völlige Handverwirklichung der Emailierung können möglichen tonalitätsverschiedenheiten ver ursachen, die in beziehung auf das Email und das Produkt mehr oder weniger betont sind.

СПЕЦИАЛЬНЫЕ ИЗДЕЛИЯ - РАКОВИНЫ: Применение спечённой основы и нанесение глазури вручную могут оказать более или менее заметное отличие в зависимости от глазури и артикула.

Variazioni di tono

Shade variations - Variations de nuance - Tonvariationen - Вариации оттенка



CARATTERISTICHE TECNICHE - ISO 13006
 TECHNICAL FEATURES - ISO 13006 / CARACTERISTIQUES TECHNIQUES - ISO 13006
 TECHNISCHE EIGENSCHAFTEN - ISO 13006

	Proprietà fisico-chimiche Physical-chemical properties / Propriétés physico-chimiques Physisch-chemische Eigenschaften	Metodo di prova Standard of test / Norme du test Testnorm		
	Dimensioni Dimensions Dimensions Abmessungen			
	Lunghezza e larghezza Length and width Longueur et largeur Länge und Breite	W 10 test		
	Spessore Thickness Epaisseur Stärke			
	Rettilineità degli spigoli Straightness of sides Rectitude des arrêtes Kantengeradheit	ISO 10545 - 2		
	Ortogonalità Rectangularity Orthogonalité Rechtwinkligkeit			
	Planarità Surface flatness Planéité Ebenflächigkeit			
	Assorbimento d'acqua Water absorption Absorption d'eau Wasseraufnahme	ISO 10545 - 3		
	Resistenza al gelo Frost resistance Résistance au gel Frostbeständigkeit	ISO 10545 - 12		
	Resistenza agli sbalzi termici Resistance to thermal shock Résistance aux écarts de température Temperaturwechselbeständigkeit	ISO 10545 - 9		
	Coefficiente di dilatazione termica lineare (50°/400°) Thermal expansion coefficient (50°/400°) Coefficient de dilatation thermique linéaire (50°/400°) Wärmeausdehnung (50°/400°)	ISO 10545 - 8		
	Resistenza al cavillo Crazing resistance Résistance à la tréaillure Haarrißbeständigkeit	ISO 10545 - 11		
	Resistenza della superficie (scala MOHS) Scratch hardness (MOHS scale) Dureté de la surface (échelle MOHS) Oberflächenhärte (MOHS skala)	EN 101		
	Resistenza alla abrasione della superficie Resistance to surface abrasion Résistance à l'abrasion de la surface Widerstand gegen Abrieb der Oberfläche	ISO 10545 - 7		
	Resistenza ai prodotti chimici di uso domestico Resistance to household chemicals Résistance aux produits chimiques ménagers Widerstand gegen Haushaltsreiniger	ISO 10545 - 13		
	Resistenza agli acidi e alle basi a bassa concentrazione Resistance to low concentrations of acids and bases Résistance aux acides et aux bases à faible concentration Widerstand gegen schwach konzentrierten Säuren und Laugen			
	Resistenza alle macchie Resistance to stains Résistance aux taches Widerstand gegen Fleckenbildner	ISO 10545 - 14		
	Piombo e cadmio rilasciati da piastrelle smaltate Lead and cadmium given off by glazed tiles Plomb et cadmium se dégageant des carreaux émaillés Von den glasierten Fliesen freigesetztes Blei und Kadmium	<table border="0"> <tr><td align="center">Piombo Lead - Plomb - Blei</td></tr> <tr><td align="center">Cadmio Cadmium - Cadmium - Kadmium</td></tr> </table>	Piombo Lead - Plomb - Blei	Cadmio Cadmium - Cadmium - Kadmium
Piombo Lead - Plomb - Blei				
Cadmio Cadmium - Cadmium - Kadmium				
	Resistenza alla flessione Bending strength Résistance à la flexion Biegezugfestigkeit	<table border="0"> <tr><td align="center">Modulo di rottura - Modulus of rupture Module de rupture - Bruchmodul</td></tr> <tr><td align="center">Carico di rottura - Breaking of rupture Charge de rupture - Bruchkraft</td></tr> </table>	Modulo di rottura - Modulus of rupture Module de rupture - Bruchmodul	Carico di rottura - Breaking of rupture Charge de rupture - Bruchkraft
Modulo di rottura - Modulus of rupture Module de rupture - Bruchmodul				
Carico di rottura - Breaking of rupture Charge de rupture - Bruchkraft				
	Caratteristiche antisdrucciolo / Coefficiente d'attrito statico Anti-slip properties / Static coefficient of friction Caractéristiques antidérapantes / Coefficient de frottement statique Rutschhemmende Eigenschaft / Statischer Reibungskoeffizient	DIN 51097 DIN 51130 ASTM C 1028 - DCOF B.C.R.A. REP. CEC. 6/81		

La tabella tecnica dei nostri prodotti è riportata all'interno dei cataloghi relativi.
 Our products' specifications are in their relevant catalogues. - Le tableau technique de nos produits se trouve dans les catalogues respectifs.
 Die Tabelle mit den technischen Angaben unserer Produkte ist im Innern der jeweiligen Kataloge enthalten.

Consigli di posa e pulizia, manutenzione, norme iso, raccomandazioni e avvertenze sul sito web www.cir.it.
 Laying and cleaning suggestion, maintenance, iso norms, additional indication on website www.cir.it.
 Conseils de pose et de nettoyage, entretien, normes ISO, renseignements et informations sur le site www.cir.it.
 Verlege- und Reinigungshinweise, Pflege, ISO-Normen und weitere Informationen auf der Webseite www.cir.it.
 Укладка и чистка, уход, спецификация, нормы ISO, общие условия продаж на сайте www.cir.it

Salvo diversa indicazione in tabella, per l'utilizzo dei detersivi in elenco seguire attentamente le indicazioni riportate sulle confezioni.

Unless otherwise indicated in the table, when using the detergents listed, follow the instructions on the pack carefully.

Sauf mention contraire dan le tableau, pour l'utilisation de détergents repris dans la liste, suivre attentivement les recommandations d'usage figurant sur l'emballage du produit.

Solange die Tabelle keine anderweitigen Angaben enthält, befolgen Sie bei der Verwendung von Reinigungsmitteln sorgfältig die Anweisungen auf den Verpackungen.

В отсутствии других указаний в таблице при применении моющих средств в списке необходимо строго придерживаться рекомендаций, указанных на упаковке.

Tipo di sporco Type of dirt Type de salete Schmutzart Вид Загрязнений	Tipo di detergente Type of detergent Type de detergent Art des reinigungsmittels Вид Моющего Средства	Nome detergenti Name of detergent Nom du detergent Name des reinigungsmittels Название Моющего Средства	Produttore Manufacturer Fabricant Hersteller Производитель
Cemento, calce, stucchi cementizi, ruggine Cement, lime, cement-based grouts, rust Ciment, chaux, enduits de ciment, rouille Zement, Kalk, Zementspachtelmasse, Rost Цемент, Известь, Цементная Затирка, Ржавчина	A base acida Acid-based A base acide Auf Säurebasis На кислотной основе	DETERDEK DELTA PLUS KERANET	FILA KERAKOLL MAPEI
Stucco epossidico Epoxy-based grouts Mastic époxy résiduelle Reste von Epoxidfugenmaterial Затирка на Эпоксидной Основе	A base alcalina Alkali-based A base alcaline Auf alkalischer Basis На щелочной основе	FILA CR10	FILA
Vino, Caffè, bibite, succhi di frutta Wine, Coffee, soft drinks, fruit juice Vin, Café, boissons, jus de fruits Wein, Kaffee, Getränke, Fruchtsäfte Вино, Кофе, Напитки, Соки	Polifunzionali, a base alcalina Multi-purpose, alkali-based Multifonction, à base alcaline Alkalische Allzweckreiniger Полифункциональные, на щелочной основе	FILA PS87	FILA
Pneumatici Tyre marks Pneumatiques Reifenschmutz Шины	A base alcalina Alkali-based A base alcaline Auf alkalischer Basis На щелочной основе	FILA PS87	FILA
Cere, grassi Wax, fats Cires, graisses Wachs, Fett Воск, Жир	A base solvente Solvent-based A base de solvant Auf Lösungsmittelbasis На основе растворителя	FILA SOLV	FILA
Patine lasciate da detersivi Residue left by detergents Patines laissées par des nettoyeurs Schleier aus Reinigungsmittelrückständen Разводы от Моющих Средств	Polifunzionali, a base alcalina Multi-purpose, alkali-based Multifonction, à base alcaline Alkalische Allzweckreiniger Полифункциональные, на щелочной основе	FILA PS87	FILA
Segni di matita, segni metallici Pencil marks, metallic marks Traces de crayon, traces métalliques Bleistift- und metallische Rückstände Следы от Карандаша, Металлические Следы	A base acida Acid-based A base acide Auf Säurebasis На кислотной основе	DETERDEK	FILA
Inchiostri, pennarello Ink, marker pens Encres, marqueurs Tinte, Filzstift Чернила, Фломастер	A base alcalina Alkali-based A base alcaline Auf alkalischer Basis На щелочной основе	FILA PS87 FILA SR95	FILA FILA
Pulizie quotidiane Everyday cleaning Nettoyage quotidien Tägliche Reinigung Ежедневная Чистка	Neutro o alcalino Neutral or alkaline Neutre ou alcalin Neutral- oder alkalische Reiniger Нейтральный или Щелочной	FILA CLEANER	FILA

(*) Eseguire sempre test preventivo sulle piastrelle prima dell'uso, in particolare su prodotti lappati o levigati.

(*) Always do a test in advance on the tiles before use, particularly on Lapper or Ground products.

(*) Toujours procéder à un essai sur les carreaux avant l'utilisation, surtout pour les articles rodés ou polis.

(*) Vor der Benutzung sollten Sie immer erst einen prophylaktischen Probeauftrag durchführen, besonders auf geläpften oder polierten Fliesen.

(*) Рекомендуется всегда проводить предварительное испытание перед использованием, особенно на лапатированной или полированной плитке.

FILA Industria Chimica S.p.A. - Via Garibaldi, 32 - 35018 San Martino di Lupari (Padova) - ITALY - Tel. 049.946.73.00 - www.filachim.com

MAPEI S.p.A. - Via Cafiero 22, 20153 Milano - ITALY - Tel. +39 02-37673 - www.mapei.it

KERAKOLL S.p.A. - Via dell'Artigianato 9 - 41049 Sassuolo (MO) - ITALY - Tel +39 0536 816 511 - www.kerakollgroup.com



Supporti per posa sopraelevata

Raised floor supports. Plots pour pose surélevée. Stelzlager fuer die schwimmende Verlegung. Опора для фальшполов



SUPPORTO FISSO
FIXED SUPPORT
SUPPORT FIXE
FESTE TRAGSTRUKTUR

h 12 mm	€ 0,50 pz
----------------	------------------

SUPPORTO REGOLABILE
ADJUSTABLE SUPPORT
SUPPORT RÉGLABLE
VERSTELLBARE TRAGSTRUKTUR

h 25/40 mm	€ 5,00 pz
h 40/70 mm	€ 5,80 pz
h 60/100 mm	€ 6,60 pz



SUPPORTO AUTOLIVELLANTE
SELF-LEVELLING SUPPORT
SUPPORT AUTONIVELANT
SELBSTNIVELLIERENDE TRAGSTRUKTUR

h 37/50 mm	€ 8,50 pz
h 50/75 mm	€ 8,90 pz



Condizioni generali di vendita

- 1. FORNITURE** - Il prezzo qui specificato si intende al netto di spese di trasporto, IVA ed eventuali diritti di dogana; per merce resa franco ns. stabilimento.
- 2. ORDINI** - Il Committente si obbliga a mantenere ferma la proposta d'ordine rilasciata a personale commerciale della ns. società. Ogni ordine trasmesso dai ns. Agenti è sempre raccolto "SALVO APPROVAZIONE DELLA CASA", per cui ci riserviamo di non accettare o modificare l'ordine stesso. Quanto sopra vale anche per eventuali cessioni gratuite per sala mostra. Prima di evadere gli ordini, l'azienda si riserva la facoltà di richiedere informazioni commerciali.
- 3. CONSEGNE** - I termini di consegna non sono mai impegnativi, ma soltanto indicativi; comunque, il mancato espletamento dell'ordine se confermato o il ritardo nella sua esecuzione escludono ogni ns. responsabilità da cause a noi non imputabili, quali impedimenti o difficoltà nei trasporti, scioperi, serrate, impossibilità o anche soltanto difficoltà di tempestivo approvvigionamento delle materie prime. Il Committente, quindi, non può in nessun caso chiedere la risoluzione del contratto o esigere indennizzi da eventuali danni diretti o indiretti per il ritardo nella consegna.
- 4. SCELTE** - Il materiale verrà consegnato nelle scelte disponibili. Pertanto, le richieste di determinate percentuali di scelta verranno intese come semplici indicazioni e soddisfatte compatibilmente con le rese di produzione.
- 5. TRASPORTO** - La merce viaggia a rischio e pericolo del Committente anche se resa franco destino e la ns. responsabilità cessa con la consegna al vettore; pertanto, i reclami per eventuali ammanchi o rotture dovranno essere rivolti esclusivamente a questi.
- 6. PREZZI** - Ci riserviamo la facoltà di modificare i prezzi del presente listino con un preavviso di 30 (trenta) giorni.
- 7. PAGAMENTI** - I pagamenti devono pervenire presso la ns. sede. L'accettazione da parte ns. di effetti o assegni emessi fuori piazza o comunque il convenuto pagamento a mezzo tratte non deroga tale condizione. Le fatture non contestate entro 8 (otto) giorni dal ricevimento si intendono accettate. I pagamenti dovranno avvenire nei modi e nei termini pattuiti nella ns. commissione. In caso di ritardato pagamento di somme a noi dovute, è ns. facoltà sospendere le forniture o annullare i rapporti in corso. Gli interessi per ritardato pagamento dovranno essere convenuti espressamente con tassi da definire.
- 8. CONTESTAZIONE PER VIZI** - Eventuali contestazioni per vizi qualsiasi sia palesi sia occulti della merce oggetto della fornitura devono essere inoltrate alla ns. sede a mezzo raccomandata con avviso di ricevimento entro 8 (otto) giorni dal ricevimento della merce. Comunque, non si accettano reclami che dovessero riguardare materiale già in opera. È espressamente esclusa la garanzia per la merce classificata di seconda o terza scelta, blocchi o partite occasionali. Offerte, transazioni, accrediti concessi dai ns. Agenti o intermediari non sono validi se non confermati per iscritto dalla ns. sede. I nostri campioni sono soltanto indicativi e vengono da noi presentati al solo scopo di fornire al cliente indicazioni di massima del prodotto.
- 9. RISERVATO DOMINIO** - La vendita della merce viene effettuata con la clausola del riservato dominio, sicché la proprietà della stessa passerà all'acquirente solo con l'integrale ed effettivo pagamento del prezzo. Il mancato pagamento anche di una sola rata produrrà lo scioglimento del contratto con la facoltà di esigere l'immediato pagamento di tutte le rate anche non scadute ovvero l'immediata restituzione della merce. In tal caso le somme versate resteranno acquisite al venditore a titolo di indennità.
- 10. FORO COMPETENTE** - Le vendite si intendono effettuate presso la ns. sede. Per ogni controversia saranno applicate le norme di legge italiane con competenza esclusiva del Tribunale di Reggio Emilia.

- **PIASTRELLE DECORATE IN ORO, PLATINO E LUSTRI** - La malta dei giunti (boiaccia) deve essere applicata con prudenza e cura. Questi metalli preziosi e nobili non si uniscono chimicamente allo smalto, ma aderiscono solamente alla superficie. Per la pulizia sono da evitare assolutamente i prodotti a base di abrasivo, gli acidi o gli alcali concentrati, nonché le basi: la decorazione non resisterebbe. L'impiego di alcool o acqua addizionata di un detergente molto leggero abituale per i tipi di stoviglie delicate non altera né lo splendore del decoro, né la bellezza della piastrella. Caratteristica degli smalti a riflesso (lustri) è la non stabilità del punto di colore.
- **DIFFERENZE DI TONALITÀ** - Le differenze di tonalità fra le piastrelle a tinta unita e le piastrelle decorate sono una caratteristica della decorazione a mano.

In base all'art.13 D.Lgs n.196/2003, Serenissima CIR Industrie Ceramiche spa è in possesso dei suoi dati per adempiere le normali operazioni derivanti da obbligo di legge o contrattuale. In qualunque momento potrà esercitare i diritti di cui all'art.7 D.Lgs n.196/2003. Il Titolare del trattamento è la scrivente Società. L'informativa completa può essere richiesta tramite email all'indirizzo serenissima@serenissimacir.it <<mailto:serenissima@serenissimacir.it>>

General terms of sale

- 1. SUPPLIES** - The price specified here is understood to be net of transport costs, VAT and any Customs charges; for goods delivered or returned free to our factory.
- 2. ORDERS** - The Customer undertakes to keep to the order proposal made to our company's sales staff. Each order transmitted by our Agents is always collected as "SUBJECT TO COMPANY APPROVAL", which means that we reserve the right to accept or to modify the order. The above also applies to any deliveries of material made free of charge for exhibition purposes. Before carrying out orders, the company reserves the right to request business information.
- 3. DELIVERIES** - Delivery terms are never binding but only indicative; however failure to carry out the order, if confirmed, or delay in carrying it out, is excluded from all liability due to reasons beyond our control, such as transport delays or difficulties, strikes, closures, or impossibility, or even due to problems with obtaining timely supplies of the raw materials. The Customer may not therefore demand termination of the agreement or demand compensation for any direct or indirect damage due to delays in delivery, in any circumstances.
- 4. SELECTIONS** - The material will be delivered in the available choices. A request for certain percentages of choices will be understood to be sheer indications, fulfilled if compatible with available yields production.
- 5. TRANSPORT** - The goods are transported at Customer's risk and peril even if delivered free destination and our liability ends with delivery to the carrier; therefore, claims for any shortages or breakages must be addressed exclusively to such carriers.
- 6. PRICES** - We reserve the right to amend the prices on this price list giving prior notice of 30 (thirty) days.
- 7. PAYMENTS** - Payments must be made at our premises. Acceptance by ourselves of non-local bills of exchange or cheques or in any case agreed payment by drafts does not vary this condition. Invoices which are not disputed within 8 (eight) days of receipt are understood to be accepted. Payments must be made in the ways and under the conditions agreed in our order. In the event of delayed payment of sums due to ourselves, we have the right to suspend supplies or to cancel current agreements. Late payment interest must be expressly agreed with rates to be defined.
- 8. DISPUTES DUE TO DEFECTS** - Any disputes due to any defects whatsoever whether evident or latent, in the goods under this agreement must be forwarded to our premises by registered post with return receipt within 8 (eight) days of receipt of the goods. However, claims involving material already laid shall not be accepted. The warranty is excluded for goods classified as being second or third choice, or occasional lots or consignments. Offers, transactions and credits conceded by our Agents or intermediaries are not valid unless confirmed in writing by our head office. Our samples are only indicative and are presented by ourselves for the sole purpose of providing the customer with general guidelines for the product.
- 9. RESERVED TITLE** - The goods are sold with the reserved title clause, as ownership of the goods is only transferred to the purchaser upon full and effective payment of the price. Failure to pay even a single instalment shall lead to termination of the agreement with the right to demand immediate payment of all instalments, even those not yet due or immediate return of the goods. In such a case the sums paid shall remain the property of the seller by way of indemnity.
- 10. PLACE OF JURISDICTION** - The sales are understood to be made from our head office. Italian law shall apply for all disputes with exclusive jurisdiction of the Court of Reggio Emilia.

- **TILES DECORATED IN GOLD, PLATINUM AND GLOSS** - The mortar (grout) must be applied prudently and with care. These precious metals do not chemically combine with the enamel but only adhere to the surface. Abrasive products, concentrated acids or alkalis and bases must not be used for cleaning under any circumstances as the decoration would be damaged. The use of alcohol or water added to a gentle detergent usually used for delicate crockery will not alter the shine of the decoration nor the beauty of the tile. A characteristic of reflective (glossed) enamels is the instability of the colour.
- **DIFFERENCE IN COLOUR TONE** - The differences in tone between the single-colour tiles and decorated tiles are a characteristic of hand-finishing.

In accordance with Article 13 of Italian Legislative Decree No. 196/2003, Serenissima CIR Industrie Ceramiche S.p.A. owns your data to carry out normal operations deriving from legal or contractual obligations. You may exercise your rights at any time, according to Article 7 of Italian Legislative Decree No. 196/2003. The Data Controller is the above-named company. The complete information document may be requested by email from the following address: serenissima@serenissimacir.it

